



Revision History

<i>Date</i>	<i>Release</i>	<i>Author</i>	<i>Description</i>
30/09/2013	1.0	Wayne Hsieh	First Release
30/09/2013	1.1	Lilian Li	Spelling correction
11/14/2013	1.2	Lilian Li	Updated to vertical housing modify the technicolor name from Technicolor R&D France to Technicolor Connected Home Rennes
01/17/2014	1.3	Lilian Li	updated WPS LED behavior
03/7/2014	1.4	Ezen Lee	Added Power consumption in networked Standby at page 3
6/12/2014	1.5	Lilian Li	updated Blue LEDs become Green LEDs
6/23/2014	1.6	Lilian Li	2.4 and 5GHz wifi LED two column have merged into one
7/1/2014	1.7	Lilian Li	updated LED behavior
11/3/2014	1.8	Lilian Li	updated Power consumption in networked Standby
4/15/2015	1.9	Lilian Li	updated LED behavior
9/7/2015	2.0	Lilian Li	Updated CE logo



Safety Instructions

Using equipment safely

Your Cable Modem Gateway product has been manufactured to meet European and local safety standards, but you must take care if you want it to perform properly and safely.

It is important that you read this booklet completely, especially the safety instructions below.

Equipment connected to the protective earth of the building installation through the mains connection or through other equipment with a connection to protective earth and to a cable distribution system using coaxial cable, may in some circumstances create fire hazard. Connection to a cable distribution system has therefore to be provided through a device providing electrical isolation below a certain frequency range (galvanic isolator, see EN 60728-11).

If you have any doubts about the installation, operation or safety of the product, please contact your supplier.

To avoid the risk of electric shock

- Disconnect the Cable Modem Gateway product from the mains supply before you connect it to (or disconnect it from) any other equipments. Remember that contact with Mains can be lethal or causes severe electric shock.
- Never remove the product cover. Should the product fail, contact the Customer Service to arrange repair or service.
- Never allow anyone to push anything into holes, slots or any other opening in the case
- Do not block the ventilation slots; never stand it on soft furnishings or carpets
- Do not put anything on it which might spill or drip into it (e.g. Lighted candles or containers of liquids). Do not expose it to dripping or splashing. If an object or liquid enters inside the Cable Modem, unplug it immediately and contact the Customer Service.
- Do not store the Cable Modem Gateway product in excessively hot, cold or damp conditions. It is intended to operate at an ambient temperature of less than 40 degrees Celsius and a maximum humidity level of 70%. In case of a storm, it is recommended that you unplug the product from the mains and from the PC set or other equipment.
- Leave the mains socket accessible so that you can unplug the set quickly
- Telephone jacks Line 1 and Line 2 must not be connected to outside wiring.

Connecting to the mains supply

- This appliance is designed to operate in the rated voltage 100 ~ 240 VAC.
- If you are in any doubt about the mains lead, the plug or connection, please consult the Customer Service.
- Only the power adapter supplied with the product has to be used.

Ensuring optimum performance

- Leave 7cm to 10cm around the appliance to ensure that proper ventilation gets to it.
- Do not store your appliance on its side (if not allowed)
- To clean the appliance, use a dry, clean soft cloth with no cleaning solvent or abrasive products. Clean the ventilation openings regularly.



Limiting the Human Body Exposure to the Electromagnetic Fields

Under normal use condition the user shall keep at least 20cm distance from the Cable Modem Gateway product.

Environmental considerations

This symbol means that your inoperative electronic appliance, and used battery when applicable, must be collected separately and not mixed with the household waste. The European Union has implemented a specific collection and recycling system for which producers' are responsible.



This appliance has been designed and manufactured with high quality materials and components that can be recycled and reused. Electrical and electronic appliances are liable to contain parts that are necessary in order for the system to work properly but which can become a health and environmental hazard if they are not handled or disposed of in the proper way. Consequently, please do not throw out your inoperative appliance with the household waste.

If you are the owner of the appliance, you must deposit it at the appropriate local collection point or leave it with the vendor when buying a new appliance.

- If you are a professional user, please follow your supplier's instructions.
- If the appliance is rented to you or left in your care, please contact your service provider

Please help us protect the environment in which we live

Energy savings - You have a role to play...

Learn how you can use and explore ways for using your electronic equipment



The user manual detailed useful information on all the features of your product but also on energy consumption performances.

We strongly encourage you to carefully read the notice before putting your equipment in service to get the best service it can offer you.

By working together, we can reduce the impact we have on our earth!

Main technical specifications

General

Operating voltage	100 ~ 240 VAC
Typical Power consumption	24 W max
Power consumption in networked Standby	<11.82W
Dimensions (W x H x D)	197mm x 138mm
Operating temperature range	0 – 40 °C
Storage temperature range	-20 – 70 °C
AC adapter (or plug-in adapter) type	ADAPTER 24W 12VDC/2A



Connections

DC input	12V/ 2A
Cable input	1xCoaxial cable connector
USB input	1x 2.0 USB connector
Phone plugs	2xRJ11
Ethernet plugs	4xRJ-45

Marking information



This symbol on your set guarantees that your product complies with the European Directive 1999/5/EC on Safety, Telecom, Electromagnetic Compatibility, with the 2009/125/EC Directive on Energy related Products and the Directive 2011/65/EU on the restriction of the use of certain hazardous substances in electrical and electronic equipment. This equipment is intended to be used indoor in a residential or office environment. This equipment may be operating in Europe

The CE Declaration of Conformity is available on the Website www.technicolor.com

Responsible Party: Technicolor Connected Home Rennes
 975, Avenue des Champs Blancs CS17616
 35576 Cesson-Sévigné Cedex
 France



Chapter 1: Connections and Setup	8
Turning on the Wireless Voice Gateway.....	8
Introduction	8
Wireless Voice Gateway Features	8
What's on the CD-ROM	9
Computer Requirements.....	9
Wireless Voice Gateway Overview.....	10
Front Panel.....	10
Rear Panel	13
Wall Mounting	15
Relationship among the Devices	16
What the Modem Does	16
What the Modem Needs to Do Its Job.....	16
Contact Your Local Cable Company	17
Connecting the Wireless Voice Gateway to a Single Computer.....	17
Attaching the Cable TV Wire to the Wireless Voice Gateway	18
Installation procedure for connecting to the Ethernet interface.....	19
Telephone or Fax Connection.....	20
Chapter 2: WEB Configuration	21
Accessing the Web Configuration	21
Outline of Web Manager	22
Warning message to change the password	23
Gateway - Status Web Page Group	24
Software.....	24
Connection.....	25
Password.....	26
Diagnostics	28
Event Log	29
Initial Scan	30
Backup/Restore.....	31
Gateway - Network Web Page Group.....	32



LAN.....	32
WAN.....	33
Computers.....	34
DDNS – Dynamic DNS service	35
Time	36
FTP Diagnostics.....	37
Port–base Passthrough.....	38
Gateway – Advanced Web Page Group.....	39
Options.....	39
IP Filtering.....	41
MAC Filtering	42
Port Filtering	43
Forwarding.....	45
Port Triggers	48
DMZ Host.....	50
RIP (Routing Information Protocol) Setup	51
Gateway – Firewall Web Page Group.....	52
Web Content Filtering.....	52
TOD Filtering.....	53
Local Log	54
Remote Log.....	55
Gateway – Parental Control Web Page Group.....	56
Basic	56
Gateway – Wireless Web Page Group	57
Radio	58
Primary Network.....	60
Access Control	67
Advanced	68
Bridging	70
802.11 Wi-Fi Multimedia:.....	71
Gateway – USB Web Page Group.....	73



Media Server	73
USB Basic settings	74
Approved Devices settings	75
Storage Basic.....	76
Storage Advanced	77
VoIP – Basic Web Page Group	78
Basic LAN	78
Hardware Info	79
Event Log	80
CM State	81
Chapter 3: Networking.....	82
Communications	82
Type of Communication	82
Cable Modem (CM) Section	83
Networking Section	83
Three Networking Modes.....	83
Cable Modem (CM) Mode.....	84
Residential Gateway (RG) Mode.....	85
Chapter 4: Additional Information	87
Frequently Asked Questions	87
General Troubleshooting	89
Service Information	90
Glossary	91



CHAPTER 1: CONNECTIONS AND SETUP

Turning on the Wireless Voice Gateway

After installing the Wireless Voice Gateway and turn it on for the first time (and each time the modem is reconnected to the power), it goes through several steps before it can be used. Each of these steps is represented by a different pattern of flashing lights on the front of the modem.

If there is no lighted LEDs on the front panel, check the power adapter plug-in the power jack and connect to CM correctly.

Note: All indicators flash once before the initialization sequence.

If both DS and US LEDs are flashing, it means the Wireless Voice Gateway is automatically updating its system software. Please wait for the lights to stop flashing. Do not remove the power supply or reset the Wireless Voice Gateway during this process.

Introduction

Wireless Voice Gateway Features

- Full Band Capture Front End.
- Increases performance with 50% increase in CPU speed.
- Adds Applications CPU to run Linux applications.
- Supports DBDC (Dual Band, Dual Concurrent).
- Lowers Power with Advanced Power Management.
- Advanced Processor architecture.
- High-Speed Memory architecture.
- Integrated IPTV solution.
- Excentis EuroDOCSIS 1.0/1.1/2.0/3.0 Standard Compliant.
- EuroPacketCable 1.0/1.5 SIP Standard Compliant (must be upgradeable to EuroPacketCable 2.0 version)
- Support Multiple Provisioning Mode.
- 4 ports Standard RJ-45 connector for 10/100/1000BaseT Ethernet with auto-negotiation and MDIX functions; Support maximum Ethernet cable length up to 100m (Category 5).
- 2 ports RJ-11 Foreign Exchange Station (FXS) port for IP telephony; Support a maximum line length between themselves and an end-receiver (handset, etc.) of up to 500 feet (AWG 26/0.4mm).
- Support simultaneous voice and data communications.
- USB: Support a maximum cable length up to 5m
- One voice conversations in the FXS port with different CODEC:
G.711-ulaw, G.711-alaw, G.723.1, BV16, ILBC, G.726-16, G.726-24, G.726-32, G.726-40, G.728, G.729, G.729E, G.729A, G.729B, TELEVENT, T.38
- Default codecs: G.711-ulaw, G.711-alaw, BV16, ILBC, TELEVENT, T.38
- Echo Cancellation.
- Voice Active Detection (VAD).
- DTMF detection and generation.
- Comfort Noise Generation (CNG).
- Support V.90 fax and modem services.
- 56 bits DES and 128 bits AES data encryption security.
- SNMP network management support.
- 802.11a/b/g/n/ac supported, 20/40/80MHz bandwidth, supports 3 × 3 antennas for data rates up to 1.3 Gbps.
- Fully IEEE 802.11a/b/g/n legacy compatibility with enhanced performance.
- Support Web pages and private DHCP server for status monitoring.
- The NTP (Network Termination Point) should be able to operate with an LF (Loading Factors) of at least 100 LU.
- TEL 1 and TEL 2 port are not connected on Hardware side.
- Propane™ technology supported, enabling the connection of more Internet users without additional network bandwidth.



What’s on the CD-ROM

Insert the Wireless Voice Gateway CD-ROM into your CD-ROM drive to view troubleshooting tips, the internal diagnostics, and other valuable information.

CD-ROM Contents:

- Electronic copy of this user’s guide in additional languages (PDF format)
- Adobe Acrobat Reader — application you can load to read PDF format, if you don’t have it loaded already
- Links to Technicolor web site

Euro-DOCSIS and Euro-PacketCable are trademarks of Cable Television Laboratories, Inc.

Computer Requirements

For the best possible performance from your Wireless Voice Gateway, your personal computer must meet the following minimum system requirements (note that the minimum requirements may vary by cable companies):

	IBM PC COMPATIBLE	MACINTOSH**
CPU	Pentium preferred	PowerPC or higher
System RAM	16MB (32MB preferred)	24MB (32MB preferred)
Operating System	Windows* NT / 2000 / Me / XP / Vista / Windows 7, Linux	Mac OS** 7.6.1 or higher
Video	VGA or better (SVGA preferred)	VGA or better (SVGA built-in preferred)
CD-ROM Drive	Required	Required
Ethernet	10BaseT , 100BaseT or 1000BaseT 10BaseT , 100BaseT or 1000BaseT An Ethernet card makes it possible for your computer to pass data to and from the internet. You must have an Ethernet card and software drivers installed in your computer. You will also need a standard Ethernet cable to connect the Ethernet card to your Wireless Voice Gateway.	
Software	<ul style="list-style-type: none"> • A TCP/IP network protocol for each machine • Microsoft Internet Explorer 4.0 or later or Netscape Navigator 4.0 or later. 	

* Windows is a trademark of Microsoft Corporation.

** Macintosh and the Mac OS are trademarks of Apple Computer, Inc.

Wireless Voice Gateway Overview

Front Panel

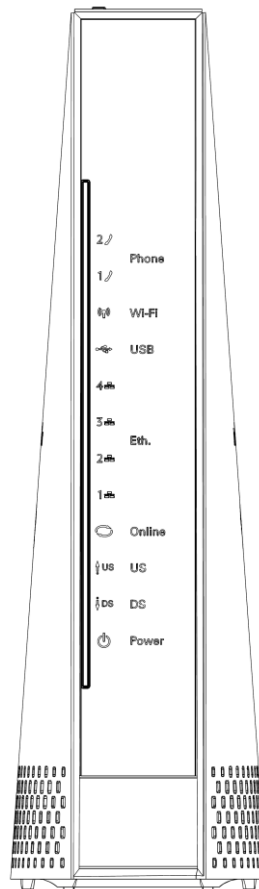









Fig. 1-1 Front Panel

The following illustration shows the front panel:

-  **Power** - Indicates the Power status.
-  **DS** - Indicates the status of Data reception by the cable modem from the Network (Downstream Traffic).
-  **US** - Indicates the status of Data transmission by the cable modem to the Network (Upstream Traffic).
-  **Online** - Displays the status of your cable connection. The light is off when no cable connection is detected and fully lit when the modem has established a connection with the network and data can be transferred.
-  **Ethernet** - Indicates the state of Ethernet ports.
-  **USB** - Indicates the state of USB host connect.
-  **Wireless** - Indicates the traffic on the wireless network.
-  **Phone** - Indicates the status of the telephone Phone 1 and Phone 2.

The lights on the front panel LEDs are described in the table below (from left to right):

ON = the LED is light, OFF = the LED is gray, FLASH = the LED is blinking.

PANEL LEDs Features	Power	Internet			Ethernet				USB	Wireless	TEL 1	TEL 2	WPS	Description					
		DS	US	Online	1	2	3	4											
Bootloader Stage	ON	ON	ON	ON	X	X	X	X	X	X	X	X	X	Power on 0.25 sec					
		0.25 second													X	X	X	X	X
Boot-up Operation	ON	FLASH	FLASH	FLASH	X	X	X	X	X	X	X	X	X	From power ON to system initialization complete					
		ON	ON	ON											X	X	X	X	X
DOCSIS Start-up Operation	ON	FLASH	OFF	OFF	X	X	X	X	X	X	X	X	X	During DS scanning and acquiring SYNC					
		ON	FLASH	OFF											X	X	X	X	X
	ON	ON	ON	FLASH	X	X	X	X	X	X	X	X	X	During DHCP, configuration file download, registration, and Baseline Privacy initialization: DHCP status: 1 second ON and 1 second OFF, TFTP status: 0.25 second ON and 0.25 second OFF					
		ON	ON	ON											X	X	X	X	X
		ON	FLASH	FLASH											OFF	X	X	X	X
ON	ON	ON	ON	X	X	X	X	X	X	X	X	X	Operational (NACO=ON)						
Partial Service (DS)	ON	FLASH	ON	ON	X	X	X	X	X	X	X	X	X	2s On, 2s Off					
Partial Service (US)	ON	ON	FLASH	ON	X	X	X	X	X	X	X	X	X	2s On, 2s Off					
CM Registration Flavors (33843)	ON	ON	ON	ON	X	X	X	X	X	X	X	X	X	Registered with CMTS					
MTA initialization	ON	ON	ON	ON	X	X	X	X	X	X	FLASH	OFF	X	MTA DHCP					
	ON	ON	ON	ON	X	X	X	X	X	X	OFF	FLASH	X	MTA SNMP/TFTP					
	ON	ON	ON	ON	X	X	X	X	X	X	ON	ON	X	RSIP for NCS/Register for SIP					
CPE Operation	ON	X	X	X	OFF ON FLASH	OFF ON FLASH	OFF ON FLASH	OFF ON FLASH	OFF ON FLASH	OFF ON FLASH	X	X	X	No Ethernet / Wireless Link Ethernet / Wireless Link TX/RX Ethernet / Wireless Traffic					
MTA Operation	ON	<CM Normal Operation>										ON	ON	X	Both Lines On-Hook				
	ON	<CM Normal Operation>										FLASH	ON			Tel1 Off-hook, Tel2 On-hook			
	ON	<CM Normal Operation>										ON	FLASH			Tel1 On-hook, Tel2 Off-hook			
	ON	<CM Normal Operation>										FLASH	FLASH			Both Lines Off-Hook			
SW Download Operation	ON	FLASH	FLASH	ON	X	X	X	X	X	X	X	X	X	A software download and while updating the FLASH memory					
WPS association	ON	X	X	X	X	X	X	X	X	X	X	X	Green FLASH 2 mins	Press >5sec to request WPS association *Green LED will blink with 2 sec On -1 sec OFF cycle					
	ON	X	X	X	X	X	X	X	X	X	X	X	Green ON 5mins	when WPS association is done *Green LED will remain ON for 300 secs before turning OFF					
	ON	X	X	X	X	X	X	X	X	X	X	X	Red FLASH	when WPS association fail after time out * Red LED will blink with 250 msec ON- 250 msec OFF					



													H 4 Sec	cycle, the LED go OFF after 4 seconds.
ON	X	X	X	X	X	X	X	X	X	X	X	X	Red FLAS H 120 Sec	when WPS association is Session Overlap *Red LED will turn ON-OFF with 250 msec duration for 2 seconds followed by turning OFF for 500 msec. *This cycle will repeat for a total duration of 120 seconds
ON	X	X	X	X	X	X	X	X	X	ON	X	X	X	press 1-3sec to enable WIFI
ON	X	X	X	X	X	X	X	X	X	OFF	X	X	x	press 1-3sec to disable WIFI

LED Status when WPS State is	
In-Progress	Green LED will blink with 2 sec On -1 sec OFF cycle
Success	Green LED will remain ON for 300 secs before turning OFF
Error"/"Timeout	Red LED will blink with 250 msec ON- 250 msec OFF cycle indefinitely
Session Overlap	Red LED will turn ON-OFF with 250 msec duration for 2 seconds followed by turning OFF for 500 msec.
This cycle will repeat for a total duration of 120 seconds.	

Table 1-1 LED behavior

Rear Panel

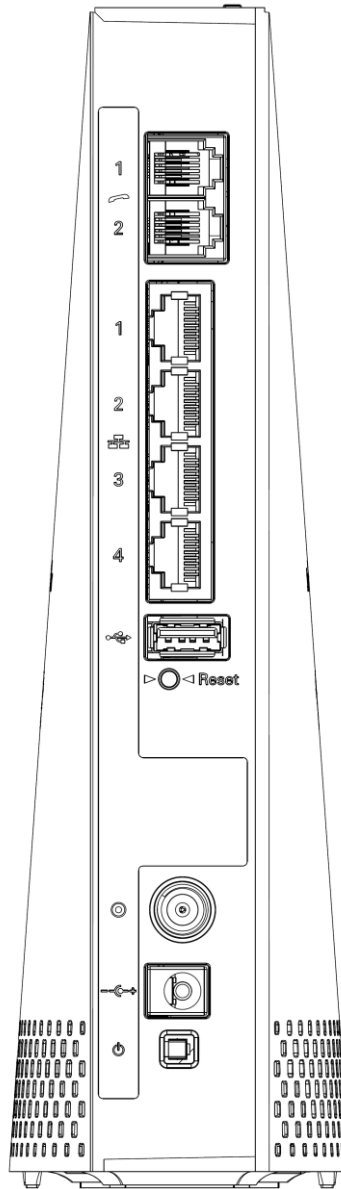

Fig. 1-2 Rear Panel

Connector	Description
Power Switch	Power on, off the Cable modem.
Power Jack	Connector for DC12V.
Cable	Connector for the cable network.
Reset	To restart the modem or press over 5 seconds can default the modem.
USB Host	USB 2.0 connector
Ethernet	4 Gige Ethernet ports, RJ-45 connector.
Phone1/ Phone2	2 Phone RJ11 Connectors.

Table 1-2 Rear Panel description



Side Panel for WPS

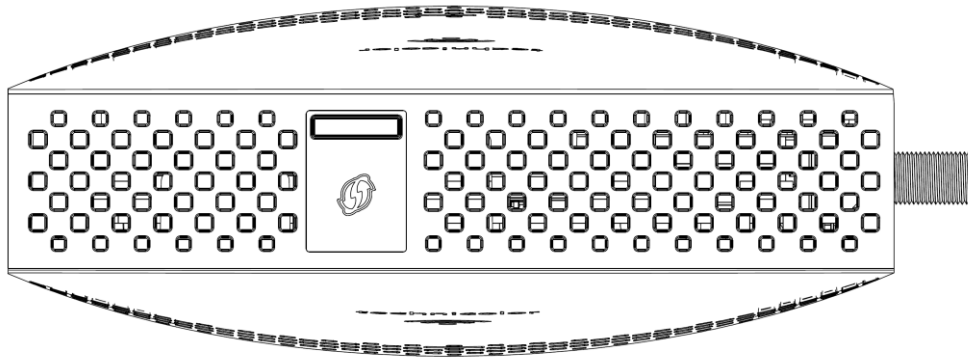

Fig. 1-3 Side Panel

 **WPS** – Indicates the status of the WPS functionality.

WPS button: Wi-Fi Protected Setup™. This button can be used to:

Secure the connection with another device (PC for example) using WPS protocol. A long press (press 5 more seconds) on the button allows you to enable the association of the modem with a PC or other equipment.

After link establish. A short press on the button, switch on/off Wi-Fi.



Wall Mounting

The number of the screw 2 pcs.

Direction for wall mounting: Tuner downward or leftward or rightward.

Dimension for the screw: diameter: 3.5mm; length: 10mm.

There are 2 slots on the underside of the CABKE MODEM that can be used for wall mounting.

Note: When wall mounting the unit, ensure that it is within reach of the power outlet.

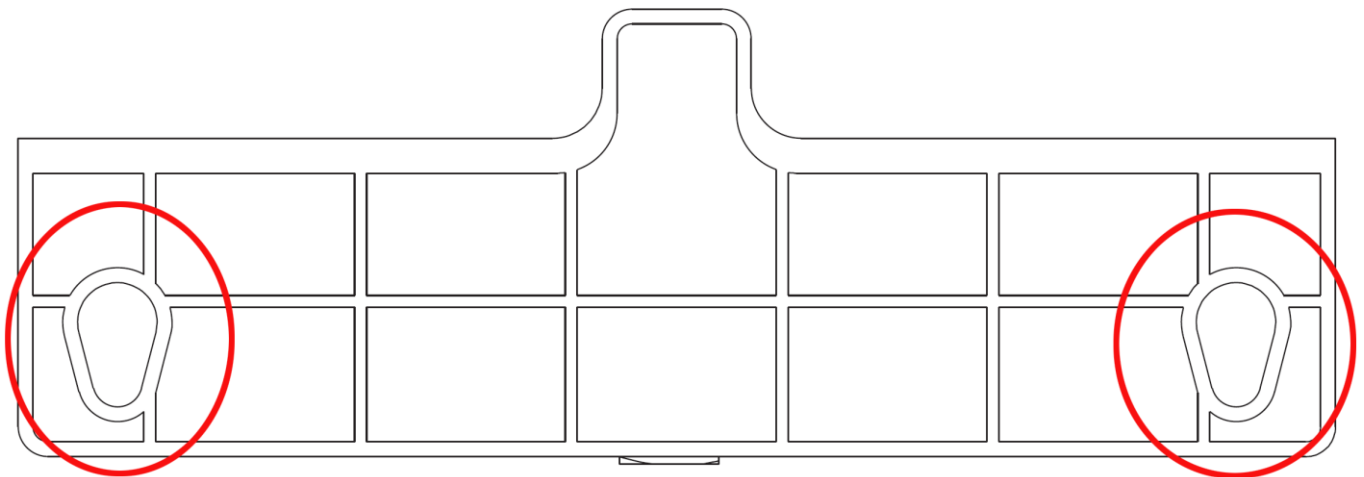

Fig. 1-4 Wall Mounting

To do this:

1. For THE CABLE MODEM, ensure that the wall you use is smooth, flat, dry and sturdy and use the 2 screw holes.
2. The unit can be to use solid concrete wall and/ or hard wood wall.

Tuner:

Note to CATV System Installer — The Coaxial cable shield shall be connected to the grounding system of the building, as close to the point of cable entry as practical.

Relationship among the Devices

This illustration shows a cable company that offers DOCSIS/Euro-DOCSIS and PacketCable/Euro-PacketCable compliant voice/data services.

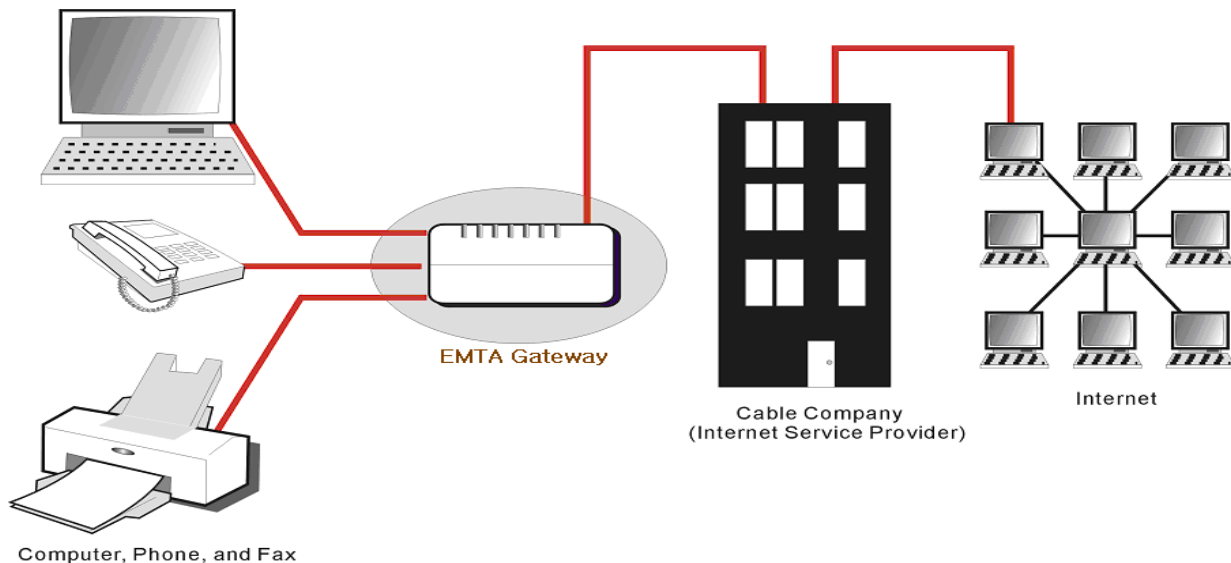

Fig. 1-5 Connection overview

What the Modem Does

The Wireless Voice Gateway provides high-speed Internet access as well as cost-effective, toll-quality telephone voice and fax/modem services over residential, commercial, and education subscribers on public and private networks via an existing CATV infrastructure. It can inter-operate with the PacketCable compliant head-end equipment and provide the IP-based voice communications. The IP traffic can transfer between the Wireless Voice Gateway and DOCSIS/Euro-DOCSIS compliant head-end equipment. The data security secures upstream and downstream communications.

What the Modem Needs to Do Its Job

- **The Right Cable Company:** Make sure your local cable company provides data services that use cable TV industry-standard DOCSIS/Euro-DOCSIS compliant and PacketCable/Euro-PacketCable compliant technology.
- **The Internet/Telephony Service Provider (ISP/TSP):** Your cable company provides you access to an Internet Service Provider (ISP) and Telephony Service Provider (TSP). The ISP is your gateway to the Internet and provides you with a pipeline to access Internet content on the World Wide Web (WWW). The TSP provides you with telephony access to other modems or other telephony services over the Public Switched Telephone Network (PSTN).

Check with your cable company to make sure you have everything you need to begin; they'll know if you need to install special software or re-configure your computer to make your cable internet service work for you.



Contact Your Local Cable Company

You will need to contact your cable company to establish an Internet account before you can use your gateway. You should have the following information ready (which you will find on the sticker on the gateway):

- The serial number
- The model number
- The Cable Modem (CM) Media Access Control (MAC) address
- The Terminal Adapter (EMTA) MAC address
- Security information: Service Set Identifier (SSID), Encryption key / passphrase (WPA2-PSK by default), channel number. Default values are indicated underneath the modem on the sticker.

Please check the following with the cable company

- The cable service to your home supports DOCSIS/Euro-DOCSIS compliant two-way modem access.
- Your internet account has been set up. (The Media Terminal Adapter will provide data service if the cable account is set up but no telephony service is available.)
- You have a cable outlet near your PC and it is ready for Cable Modem service.

Note: It is important to supply power to the modem at all times. Keeping your modem plugged in will keep it connected to the Internet. This means that it will always be ready whenever you need.

Important Information

Your cable company should always be consulted before installing a new cable outlet. Do not attempt any rewiring without contacting your cable company first.

Please verify the following on the Wireless Voice Gateway

The Power LED should be lighted when plug-in the power supply.

Connecting the Wireless Voice Gateway to a Single Computer

This section of the manual explains how to connect your Wireless Voice Gateway to the Ethernet port on your computer and install the necessary software. Please refer to Figure 1-5 to help you connect your Digital Cable Modem for the best possible connection.



Attaching the Cable TV Wire to the Wireless Voice Gateway

1. Locate the Cable TV wire. You may find it one of three ways:
 - a. Connected directly to a TV, a Cable TV converter box, or VCR. The line will be connected to the jack, which should be labeled either IN, CABLE IN, CATV, CATV IN, etc.
 - b. Connected to a wall-mounted cable outlet.
 - c. Coming out from under a baseboard heater or other location. See Figure 1-6 for the wiring example.

Notes: For optimum performance, be sure to connect your Wireless Voice Gateway to the first point the cable enters your home. The splitter must be rated for at least 1GHz.

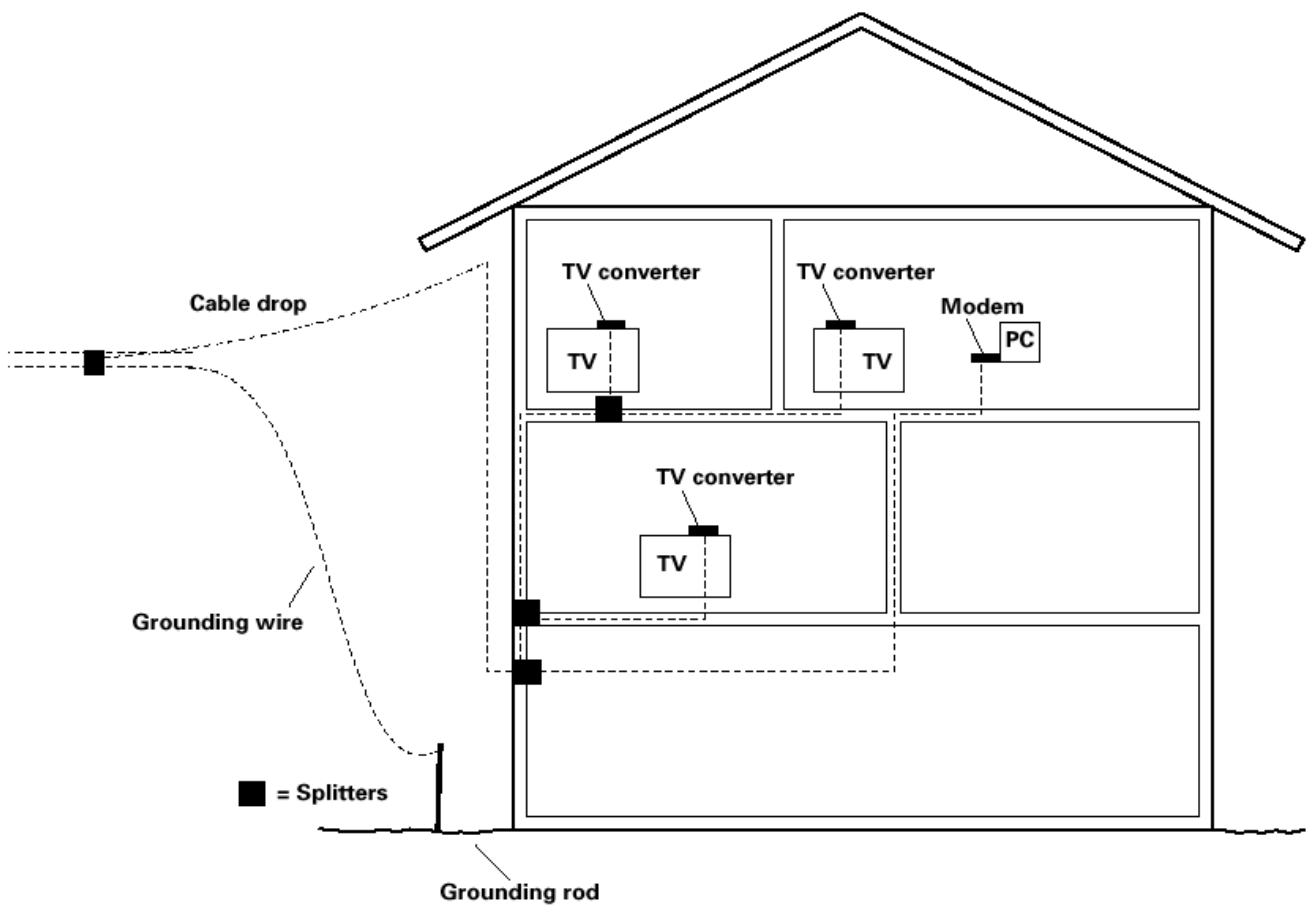

Fig. 1-6 Basic Home Wiring

Installation procedure for connecting to the Ethernet interface

Follow these steps for proper installation.

Plug the coaxial cable to the cable wall outlet and the other end to the modem's cable connector.

Note: To ensure a fast registration of the modem, the coaxial cable must be connected to the modem before it is powered on.

Plug the power supply into the socket of the cable modem and two-pin plug in the AC outlet then press the Power Switch, power on the modem.

Note: Only use the power supply that comes with the modem. Using another power supply can cause damage to the product, and will void the warranty.

Connect an Ethernet cable (direct connection, see below) to the Ethernet port at the back of the computer, and the other end to the ETHERNET port on the rear panel of the cable modem. The modem will seek the appropriate cable signal on the cable television network and go through the initial registration process on its own. The modem is ready for data transfer after the green LED "ONLINE" is lit continuously.

Note: the button "reset" at the back of the modem is used primarily for maintenance.

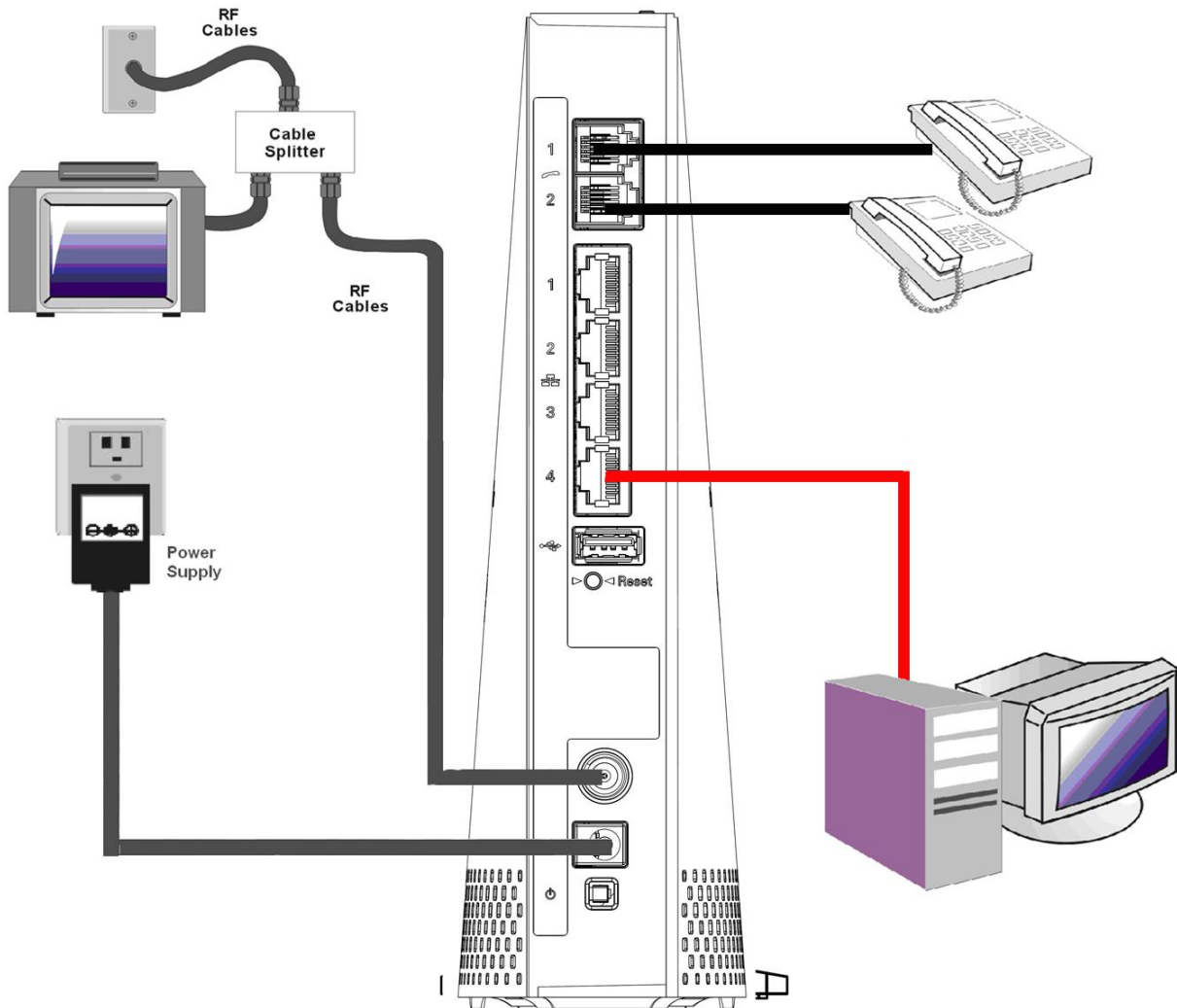

Fig. 1-7 Connect to the Modem



Telephone or Fax Connection

When properly connected, most telephony devices can be used with the Wireless Voice Gateway just as with a conventional telephone service. To make a normal telephone call, pick up the handset; listen for a dial tone, then dial the desired number. For services such as call waiting, use the hook switch (or FLASH button) to change calls. The following procedures describe some of the possible connection schemes for using telephony devices with the Wireless Voice Gateway.

1. Connect a standard phone line cord directly from the phone (fax machine, answering machine, caller ID box, etc.) to one of the LINE jacks on the Wireless Voice Gateway.
2. If there is a phone line in your home which is NOT connected to another telephone service provider, connect a standard phone line cord from a jack on this line to one of the LINE jacks of the Wireless Voice Gateway. Connect a standard phone line cord directly from the phone (fax machine, answering machine, caller ID box, etc.) to one of the other jacks in the house that uses that line.
3. If you have a multi-line telephone, connect a standard phone line cord (not an RJ-14 type line cord) from the phone to the LINE jacks on the Wireless Voice Gateway. (Other phones can be added to each line by using standard phone line splitters.)

CHAPTER 2: WEB CONFIGURATION

To make sure that you can access the Internet successfully, please check the following first.

1. Make sure the connection (through Ethernet) between the Wireless Voice Gateway and your computer is OK.
2. Make sure the TCP/IP protocol is set properly.
3. Subscribe to a Cable Company.

Accessing the Web Configuration

The **Wireless Voice Gateway** offers local management capability through a built-in HTTP server and a number of diagnostic and configuration web pages. You can configure the settings on the web page and apply them to the device.

Once your host PC is properly configured; please proceed as follows:

1. Start your web browser and type the private IP address of the Wireless Voice Gateway on the URL field: **192.168.0.1**
2. After connecting to the device, you will be prompted to enter username and password. By default, the username is “ ” (empty) and the password is “**admin**”.



Fig2-1 Login dialogue

If you login successfully, the main page will appear.

Note: If forget your username and password, you may Press "Reset" button on the rear panel more than 5seconds to restore the username and password to default.

Outline of Web Manager

The main screen will be shown as below.

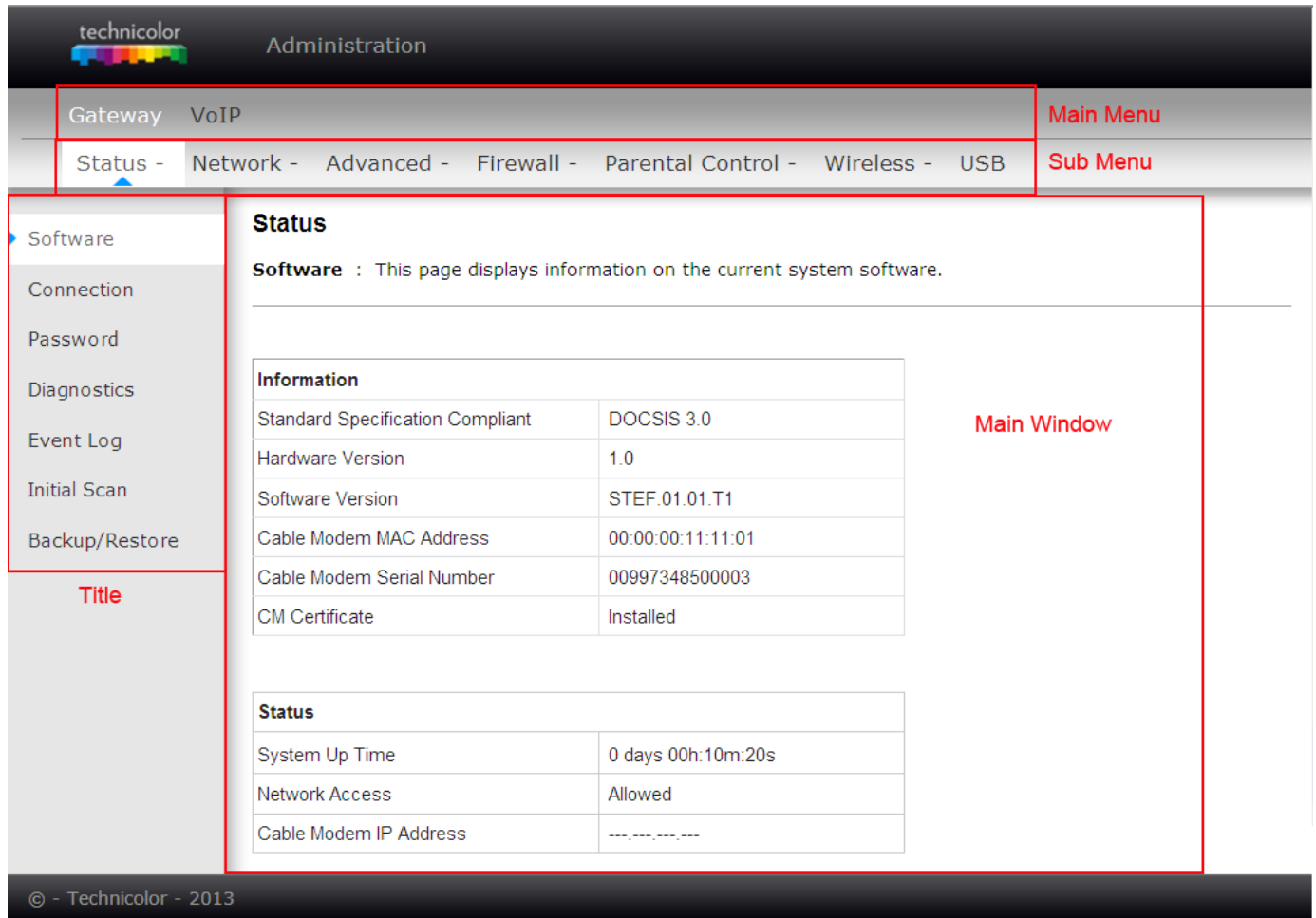

The screenshot shows the Technicolor Administration web interface. At the top, there is a navigation bar with 'Gateway' and 'VoIP' tabs. Below this is a 'Main Menu' and 'Sub Menu' section. The 'Sub Menu' includes links for 'Status', 'Network', 'Advanced', 'Firewall', 'Parental Control', 'Wireless', and 'USB'. On the left, a sidebar lists various functions: 'Software', 'Connection', 'Password', 'Diagnostics', 'Event Log', 'Initial Scan', and 'Backup/Restore'. The 'Software' option is selected, and the 'Title' of the page is 'Software'. The main content area, labeled 'Main Window', displays the 'Status' page for software. It includes a description: 'Software : This page displays information on the current system software.' Below this are two tables: 'Information' and 'Status'.

Information	
Standard Specification Compliant	DOCSIS 3.0
Hardware Version	1.0
Software Version	STEF.01.01.T1
Cable Modem MAC Address	00:00:00:11:11:01
Cable Modem Serial Number	00997348500003
CM Certificate	Installed

Status	
System Up Time	0 days 00h:10m:20s
Network Access	Allowed
Cable Modem IP Address	---:---:---

Fig. 2-2 Outline of Web Manager

- **Main Menu:** the hyperlinks on the top of the page, including Gateway, VoIP and several sub-menu items
- **Sub Menu:** under the main menu, sub menu use to enter each function, e.g., Status, Network, Firewall...
- **Title:** the sidebar on the left side of the page indicates the title of this management interface, e.g., Software in this example
- **Main Window:** the current workspace of the web management, containing configuration or status information

For easy navigation, the pages are organized in groups with group in names main menu. Individual page names within each group are provided in the sub menu and sidebar. So to navigate to a page, click the group hyperlink at the top, then the sub menu for the function, finally choose the title on the sidebar.

Your cable company may not support the reporting of some items of information listed on your gateway's internal web pages. In such cases, the information field appears blank. This is normal.



Warning message to change the password

At your first connection or while the password is the default one, a warning message is displayed on the top banner of each Web configuration page. We want to encourage you to change the password in order to enforce the security of your modem. Please refer to the chapter **password** page 25 for more information.

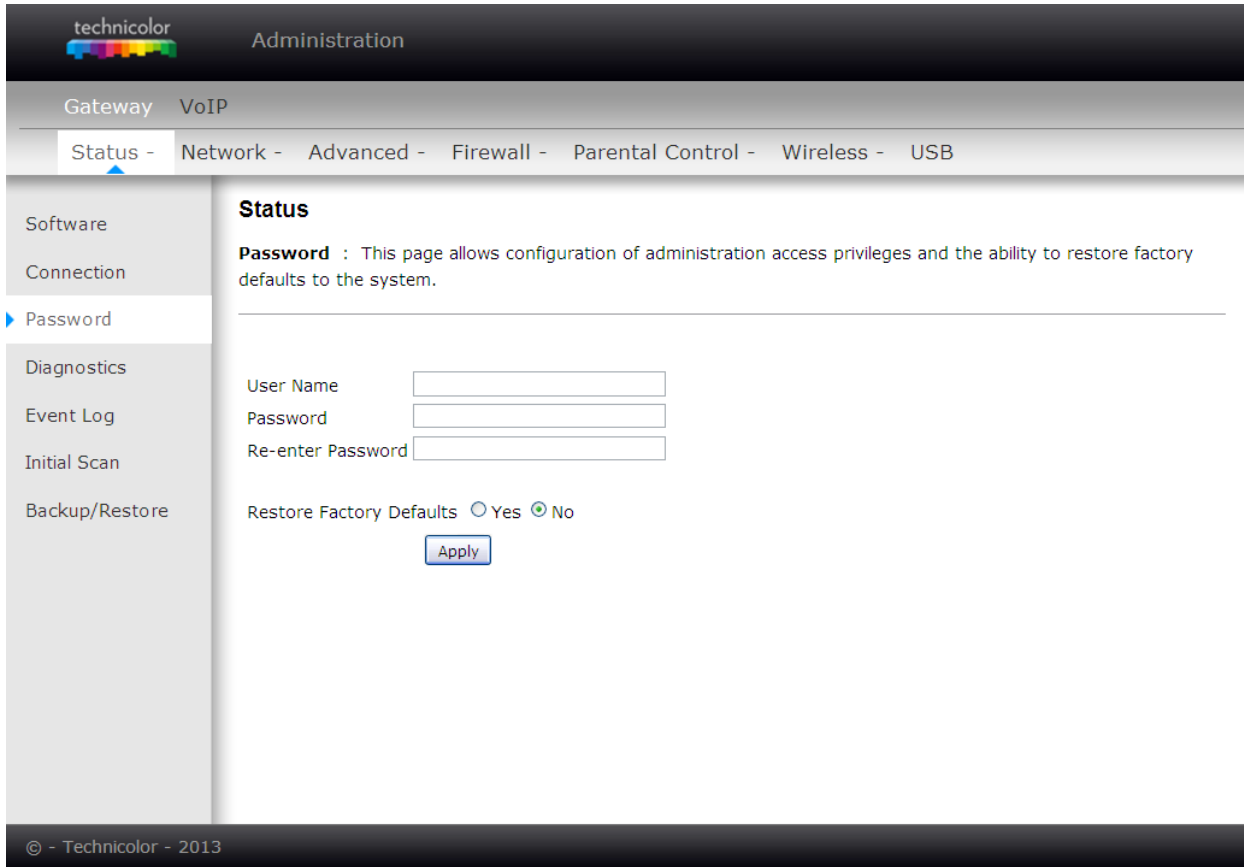

Fig. 2-3 Gateway\Status\Password

To change the password: type the password, and re-enter it again.
 If the password is accepted, you are required to re log on the web pages:



Fig. 2-4 Password request dialog



Gateway – Status Web Page Group

Software

The information section shows the hardware and software information about your gateway.

The status section of this page shows how long your gateway has operated since last time being powered up, and some key information the Cable Modem received during the initialization process with your cable company. If Network Access shows “Allowed,” then your cable company has configured your gateway to have Internet connectivity. If not, you may not have Internet access, and should contact your cable company to resolve this.

The screenshot shows the Technicolor Gateway Administration interface. The breadcrumb trail is: Administration > Gateway > VoIP > Status > Software. The left sidebar contains navigation options: Software (selected), Connection, Password, Diagnostics, Event Log, Initial Scan, and Backup/Restore. The main content area is titled 'Status' and includes a description: 'Software : This page displays information on the current system software.'

There are two tables displayed:

Information	
Standard Specification Compliant	DOCSIS 3.0
Hardware Version	1.0
Software Version	STEF.01.01.T1
Cable Modem MAC Address	00:00:00:11:11:01
Cable Modem Serial Number	00997348500003
CM Certificate	Installed

Status	
System Up Time	0 days 00h:10m:20s
Network Access	Allowed
Cable Modem IP Address	-----

© - Technicolor - 2013

Fig.2-5 Gateway\Status\Software



Connection

This page reports current connection status containing startup procedures, downstream and upstream status, CM online information, and so on. The information can be useful to your cable company's support technician if you're having problems.

technicolor
Administration

Gateway
VoIP

Status -
Network - Advanced - Firewall - Parental Control - Wireless - USB

Software

▶ Connection

Password

Diagnostics

Event Log

Initial Scan

Backup/Restore

Status

Connection : This page displays information on the status of the cable modem's HFC and IP network connectivity.

Startup Procedure

Procedure	Status	Comment
Acquire Downstream Channel		Locked
Connectivity State	OK	Operational
Boot State	OK	Operational
Configuration File	OK	
Security	Disabled	Disabled

Downstream Channel

Channel	Lock Status	Modulation	Channel ID	Symbol Rate	Frequency	Power	SNR
1	Locked	QAM256	1	6952000		4.0 dBmV	46.4 dB
2	Locked	QAM256	2	6952000		3.5 dBmV	47.4 dB
3	Locked	QAM256	3	6952000		3.4 dBmV	47.5 dB
4	Locked	QAM256	4	6952000		3.1 dBmV	44.9 dB
5	Locked	QAM256	5	6952000		2.9 dBmV	44.7 dB
6	Locked	QAM256	6	6952000		2.7 dBmV	46.8 dB
7	Locked	QAM256	7	6952000		2.3 dBmV	46.8 dB
8	Locked	QAM256	8	6952000		2.0 dBmV	44.9 dB
9	Not Locked	Unknown	0	Unknown		0.0 dBmV	0.0 dB
10	Not Locked	Unknown	0	Unknown		0.0 dBmV	0.0 dB
11	Not Locked	Unknown	0	Unknown		0.0 dBmV	0.0 dB
12	Not Locked	Unknown	0	Unknown		0.0 dBmV	0.0 dB
13	Not Locked	Unknown	0	Unknown		0.0 dBmV	0.0 dB
14	Not Locked	Unknown	0	Unknown		0.0 dBmV	0.0 dB
15	Not Locked	Unknown	0	Unknown		0.0 dBmV	0.0 dB
16	Not Locked	Unknown	0	Unknown		0.0 dBmV	0.0 dB

Upstream Channel

Channel	Lock Status	Modulation	Channel ID	Symbol Rate	Frequency	Power
1	Locked	QAM64	3	5120 Ksym/sec		37.5 dBmV
2	Locked	QAM64	2	5120 Ksym/sec		36.5 dBmV
3	Locked	QPSK	1	2560 Ksym/sec		36.5 dBmV
4	Locked	QAM64	4	5120 Ksym/sec		36.9 dBmV

CM IP Address	Duration	Expires
-----:--:--	D: -- H: -- M: -- S: --	-----:--:--:--

Current System Time: Fri Sep 27 14:18:46 2013

© - Technicolor - 2013

Fig. 2-6 Gateway\Status\Connection



Password

By default, the username is empty (“”) and the password is “**admin**”.

This is set by different actions (non exhaustive list):

- at the manufactory level,
- following a reset factory on the modem,
- following a reset from the operator,
- following a change by the user who wants to come back to the default setting after using its own settings

When the current password is the default one, the user is strongly encouraged to change the default web password.

At your first connection or while the password is the default one, a warning message is displayed on the top banner of each Web configuration page. We want to encourage you to change the password in order to enforce the security of your modem.

The password can be a maximum of 8 characters and is case sensitive. In addition, this page can be used to restore the gateway to its original factory settings. Use this with caution, as all the settings you have made will be lost. To perform this reset, set **Restore Factory Defaults** to **Yes** and click **Apply**. This has the same effect as a factory reset using the rear panel reset switch, where you hold on the switch for 5 seconds, then release it.

Note: We are always suggesting you to modify the password. This is a basic protection against wrongful access to the Gateway Web pages.

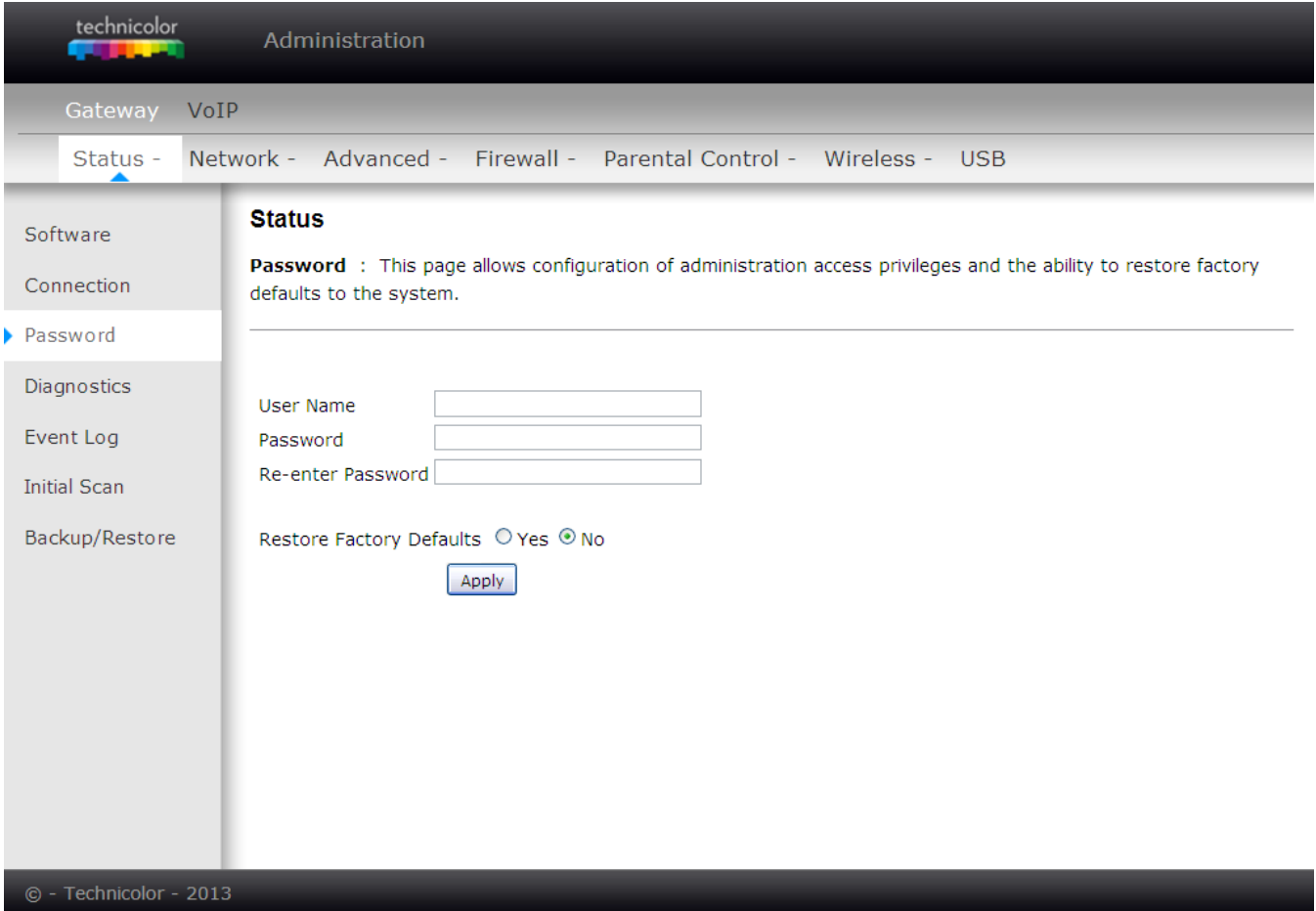

Fig. 2-7 Gateway\Status>Password



To change the password: type the password, and re-enter it again.

If the password is accepted, you are required to re log on the web pages:



Fig. 2-8 Password request dialog

If the password is no accepted, an error message is displayed:

HTTP 401 - Unauthorized

Authorization is required to access the configuration server.

You must enter the correct username and/or password.

Please reflash the web and wait for Password dialog pop-up, then typing the correct username and password again.



Diagnostics

This page offers basic diagnostic tools for you to use when connectivity problems occur. When you ping an Internet device, you send a packet to its TCP/IP stack, and it sends one back to yours. To use the ping Test, enter the information needed and press Start Test; the Result will be displayed in the lower part of the window. Press Abort Test to stop, and Clear Results to clear the result contents. Note: Firewalls may cause pings to fail but still provide you TCP/IP access to selected devices behind them. Keep this in mind when ping a device that may be behind a firewall. Ping is most useful to verify connectivity with PCs which do not have firewalls, such as the PCs on your LAN side.

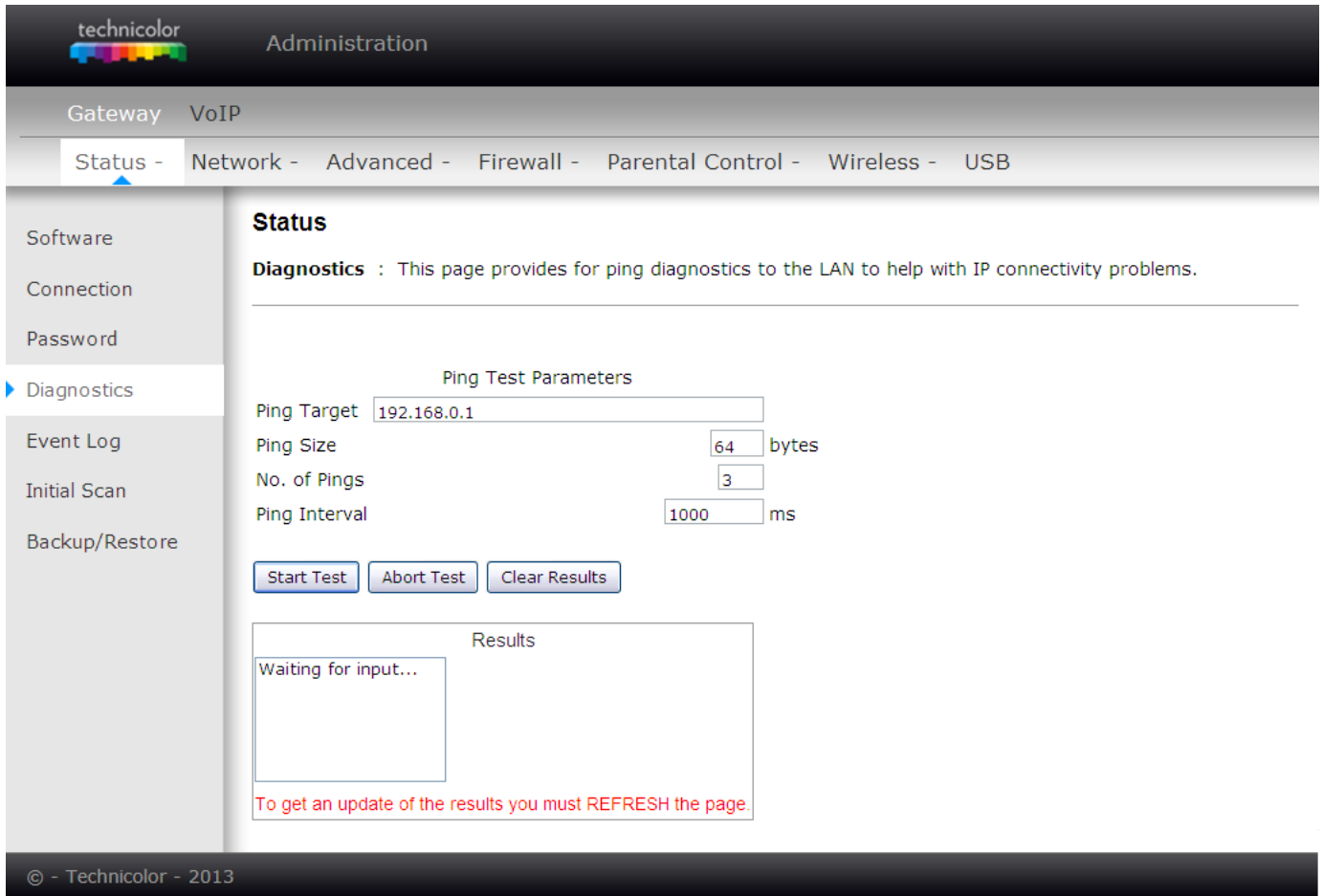

Fig. 2-9 Gateway\Status\Diagnostics



Event Log

This page displays the contents of the SNMP event log. Press “**Clear Log**” button to clear the logs.

technicolor Administration

Gateway VoIP

Status - Network - Advanced - Firewall - Parental Control - Wireless - USB

Software
Connection
Password
Diagnostics
▶ Event Log
Initial Scan
Backup/Restore

Status

SNMP Event Log : This page displays the contents of the SNMP event log.

Time	Priority	Description
Time Not Established	Warning (5)	DHCP WARNING - Non-critical field invalid in response ;CM-MAC...
Time Not Established	Notice (6)	Honoring MDD; IP provisioning mode = IPv4
Time Not Established	Notice (6)	WiFi Interface [wl1] set to Channel 36 (Side-Band Channel:N/A...
Time Not Established	Notice (6)	WiFi Interface [wl0] set to Channel 6 (Side-Band Channel:N/A)...
Tue Sep 17 10:16:59 2013	Critical (3)	Resetting the cable modem due to console command

Clear Log

© - Technicolor - 2013

Fig. 2-10 Gateway\Status\Event Log



Initial Scan

To speed up the modem's first time connection, enter known downstream frequency and/or upstream channel ID information here. Then click "**Apply and Reboot**" button to start scanning the cable network beginning with the values supplied here.

The value is provided in Hertz. So, for 549 MHz, you must type: 549000000

The screenshot shows the Technicolor Administration web interface. At the top, there is a navigation bar with the Technicolor logo and the word "Administration". Below this, there are tabs for "Gateway" and "VoIP". A secondary navigation bar contains links for "Status", "Network", "Advanced", "Firewall", "Parental Control", "Wireless", and "USB". On the left side, there is a vertical menu with options: "Software", "Connection", "Password", "Diagnostics", "Event Log", "Initial Scan" (which is highlighted with a blue arrow), and "Backup/Restore". The main content area is titled "Status" and contains the following text: "Initial Scan : To speed up the modem's first time startup, enter known downstream frequency and/or upstream channel ID information here. Then click the 'Apply' button. The modem will start scanning the cable network beginning with the values supplied here." Below this text, there are two input fields: "Initial DS Frequency : 549000000" and "Upstream Channel ID: 3". An "Apply" button is located below these fields. At the bottom of the page, there is a footer that reads "© - Technicolor - 2013".

Fig. 2-11 Gateway\Status\Initial Scan



Backup/Restore

Backup/Restore Settings: This page allows you to save your current settings locally on your PC, or restore settings previously saved. The default file name is “GatewaySettings.bin”.

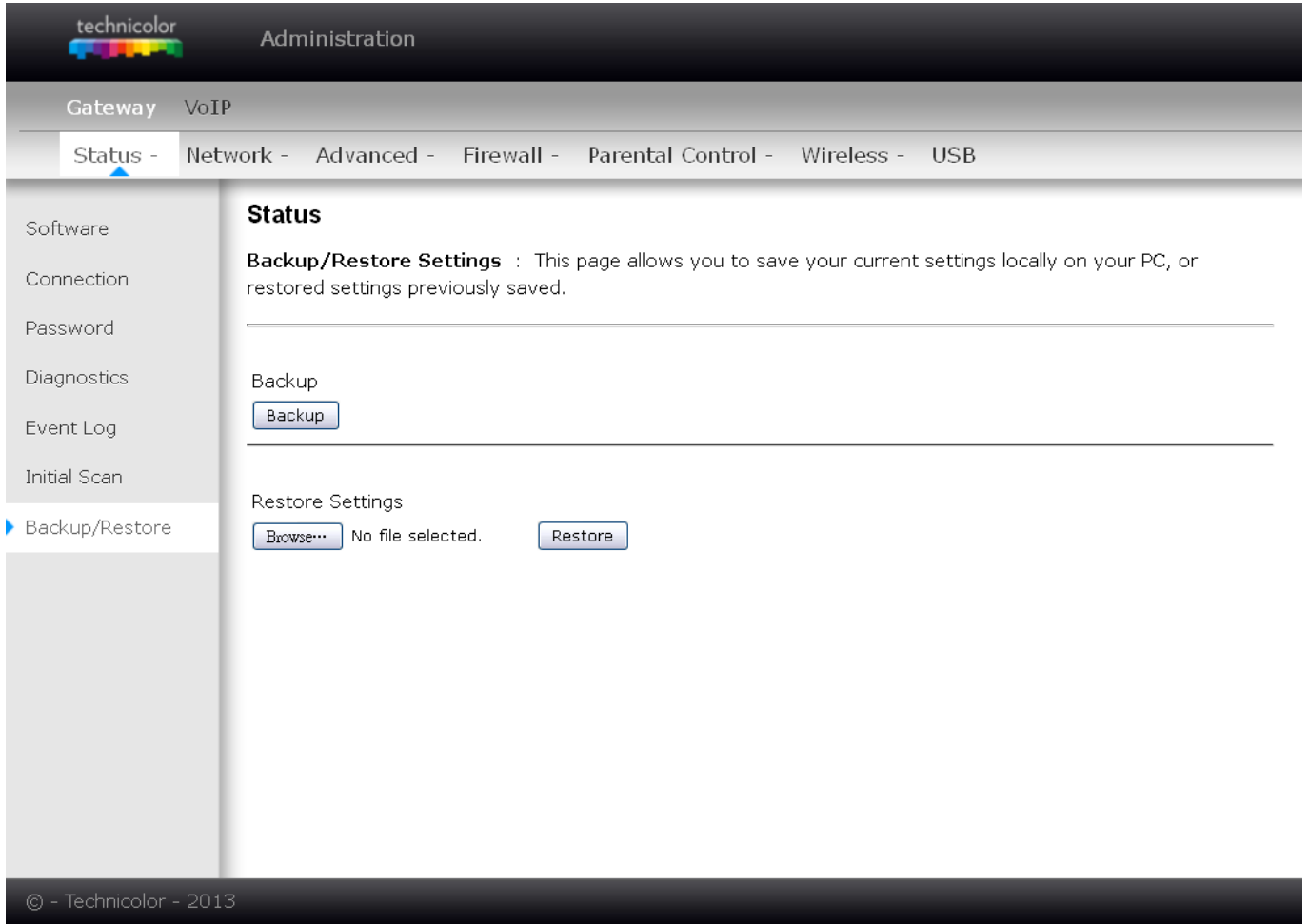

Fig 2-12 Gateway\Status\ Backup/Restore

Gateway – Network Web Page Group

LAN

You can activate the DHCP server function for the LAN on this page.

With this function activated,

- your cable company’s DHCP server provides one IP address for your gateway,
- and your gateway’s DHCP server provides IP addresses, starting at the address you set in IP Address on the LAN page, to your PCs. A DHCP server leases an IP address with an expiration time.

To change the IP address that your gateway will use on the LAN side, enter it into the **IP Address** box and then click **Apply**.

IP Address and Subnet Mask:

A private IP address and Subnet Mask for LAN sub netting.

For example 192.168.0.1 / 255.255.255.0.

DHCP Server:

- Select the check point of “Yes” or “No” to enable or disable a simple DHCP server for LAN.
- Configure the IP address numbers for the DHCP server with “Lease pool start” and “Lease pool end”.
- Configure the IP address lease time with “Lease time” for DHCP server. Default value is 604800 seconds.

The screenshot shows the Technicolor Administration interface. The top navigation bar includes 'Gateway' and 'VoIP'. Below it, a menu shows 'Status', 'Network', 'Advanced', 'Firewall', 'Parental Control', 'Wireless', and 'USB'. The left sidebar lists various settings: LAN, WAN, Computers, DDNS, Time, FTP Diagnostics, Portbase, and Passthrough. The main content area is titled 'Network' and contains the following information:

- LAN** : This page allows configuration and status of the optional internal DHCP server for the LAN.
- None Specified
- Network Configuration**
- IPv6 Address: **Unspecified**
- IPv6 Prefix: **::**
- IPv4 Address:
- Subnet Mask:
- MAC Address: **00:10:95:de:ad:05**
- Interface/Prefix**
- DHCP Server: Yes No
- Lease Pool Start:
- Lease Pool End:
- Lease Time:
-

© - Technicolor - 2013

Fig. 2-13 Gateway\Network\LAN



WAN

You can configure the optional internal DHCP server for the WAN on this page. This can be required by some ISP providers.

Select different WAN Connection Type will lead to different contents. Take the WAN connection type-DHCP for example, you can release and renew the WAN lease by pressing the buttons.

You can enter a spoofed MAC address that causes your gateway networking stack to use that MAC address when communicating instead of the usual WAN MAC address, e.g., if the MAC address is `00:10:18:de:ad:03`, this spoofed MAC address could be `00:11:e3:df:ad:05` or any desired MAC address.

The screenshot shows the Technicolor Administration interface. The top navigation bar includes 'Gateway' and 'VoIP'. Below it, a breadcrumb trail shows 'Status - Network - Advanced - Firewall - Parental Control - Wireless - USB'. The left sidebar contains a menu with 'LAN', 'WAN', 'Computers', 'DDNS', 'Time', 'FTP Diagnostics', 'Portbase', and 'Passthrough'. The main content area is titled 'Network' and contains the following information:

WAN : This page allows configuration and status of the internal DHCP client for the WAN.

WAN

IPv6 Address: **fe80::210:95ff:fede:ad03/64**
 Duration: **D: 00 H: 00 M: 00 S: 00**
 Expires: **Fri Sep 27 14:41:50 2013**

IPv4 Address: **10.10.146.157**
 MAC Address: **00:10:95:de:ad:03**
 Duration: **D: 01 H: 00 M: 00 S: 00**
 Expires: **Sat Sep 28 14:07:39 2013**

IPv4 DNS Servers: **10.10.159.253**
 IPv6 DNS Servers: **None**

Buttons:

WAN Connection Type:

Ipv4 MTU Size: (256-1500 octets, 0 = use default)

Spoofed MAC Address: : : : : :

© - Technicolor - 2013

Fig.2-14 Gateway\Network\WAN

Computers

This page displays the status of the DHCP clients and current system time. You can cancel an IP address lease by selecting it in the DHCP Client Lease Info list and then clicking the Force Available button. If you do so, you may have to perform a DHCP Renew on that PC, so that it can obtain a new lease.

technicolor Administration

Gateway VoIP

Status - Network - Advanced - Firewall - Parental Control - Wireless - USB

LAN

WAN

Computers

DDNS

Time

FTP Diagnostics

Portbase

Passthrough

Network

Computers : This page shows the status of the DHCP clients and current system time.

DHCP Clients

MAC Address	IP Address	Subnet Mask	Duration	Expires	Select
001095dead07	192.168.000.010	255.255.255.000	D:07 H:00 M:00 S:00	Fri Oct 04 14:08:03 2013	<input type="radio"/>

Current System Time : Fri Sep 27 14:42:36 2013

Stateless Auto Configuration

IP Address	MAC Address	Reachability State

© - Technicolor - 2013

Fig.2-15 Gateway\Network\Computers



DDNS - Dynamic DNS service

This page allows to setup for Dynamic DNS server.

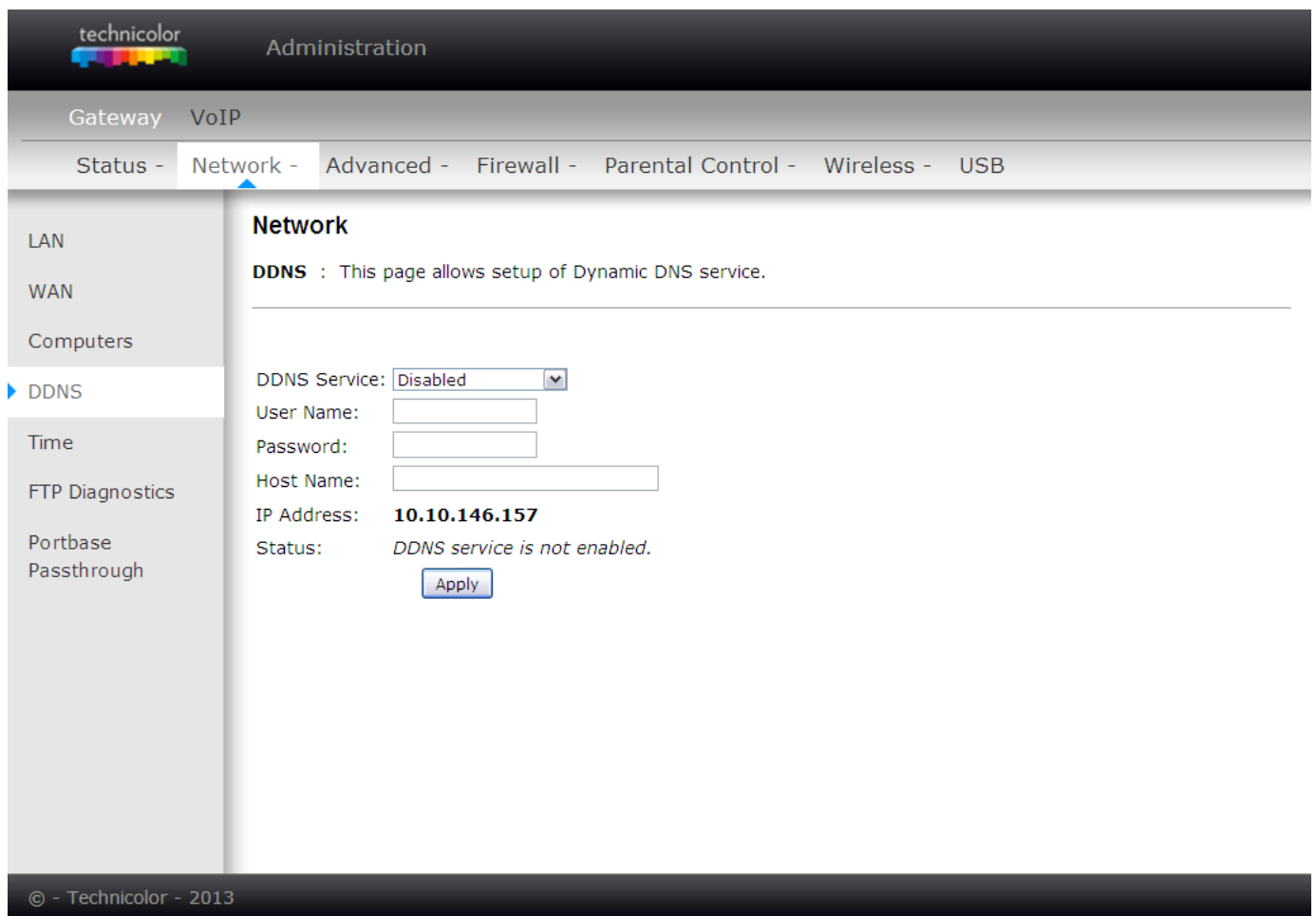

Fig.2-16 Gateway\Network\DDNS

- **DDNS Service-** Choose Enabled (www.DynDNS.org) to enable the basic setting. Choose Disabled to close the basic setting.
- **Username-** The username that you registered with your DDNS provider.
- **Password-** The password that you registered with your DDNS provider
- **Host Name-** The domain name or host name that is registered with your DDNS provider
- **Status-** It shows the DDNS service status whether it is enabled or disabled.

Click Apply to save the changes.

Time

This page allows configuration and display of the system time obtained from network servers via Simple Network Time Protocol. The system has to be reset for any changes to take effect.

technicolor Administration

Gateway VoIP

Status - Network - Advanced - Firewall - Parental Control - Wireless - USB

LAN
WAN
Computers
DDNS
▶ Time
FTP Diagnostics
Portbase
Passthrough

Network

Time : This page allows configuration and display of the system time obtained from network servers via Simple Network Time Protocol. The system has to be reset for any changes to take effect.

Enable SNTP Yes No

Current Time Fri Sep 27 14:43:05 2013

System Start Time Fri Sep 27 14:06:40 2013

Time Server 1

Time Server 2

Time Server 3

Timezone Offset Hours Minutes

© - Technicolor - 2013

Fig.2-17 Gateway\Network\Time

FTP Diagnostics

This page allows to test download and upload transmit rate through FTP. Choose known FTP server and FileName with correct username and password then choose direction to Download or Upload. Press the 'Start' button to start.

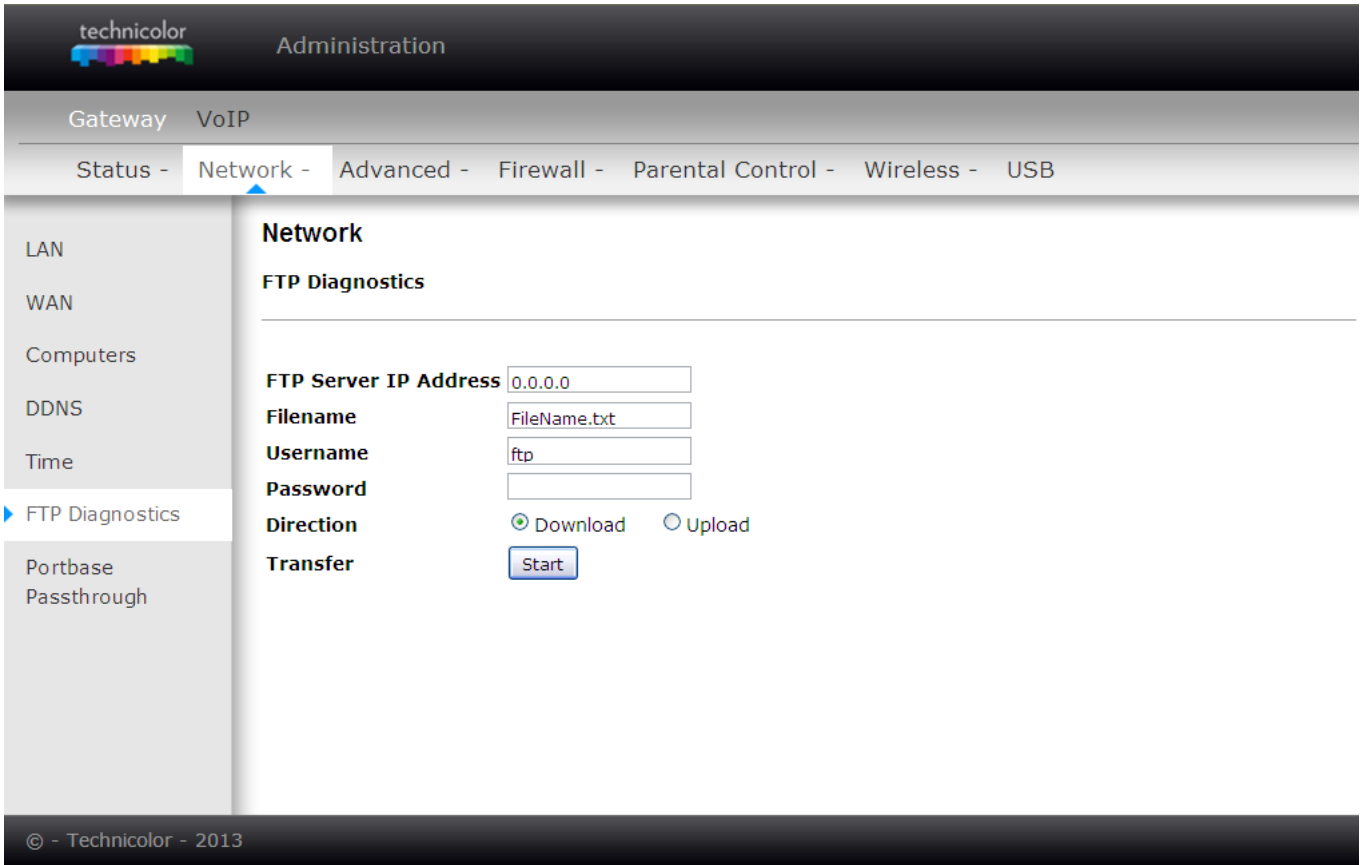

Fig.2-18 Gateway\Network\FTP Diagnostics

You will see the result on the page, when transmit done.

FTP Download	
Payload Data Bytes	6296 bytes
Total Packet Bytes	6752 bytes
Elapsed Time	0.027260 Secs
Payload Throughput	1.847689 Mbps
Packet Throughput	1.981511 Mbps

Fig.2-19 Gateway\Network\FTP Diagnostics\test result



Port-base Passthrough

This page allows the configuration of each Ethernet Port. Per default, each Ethernet port is routed. If you enable the Passthrough, the Ethernet Port will have a direct connection to the Network. Note that access to this web access can be denied by your Cable operator.

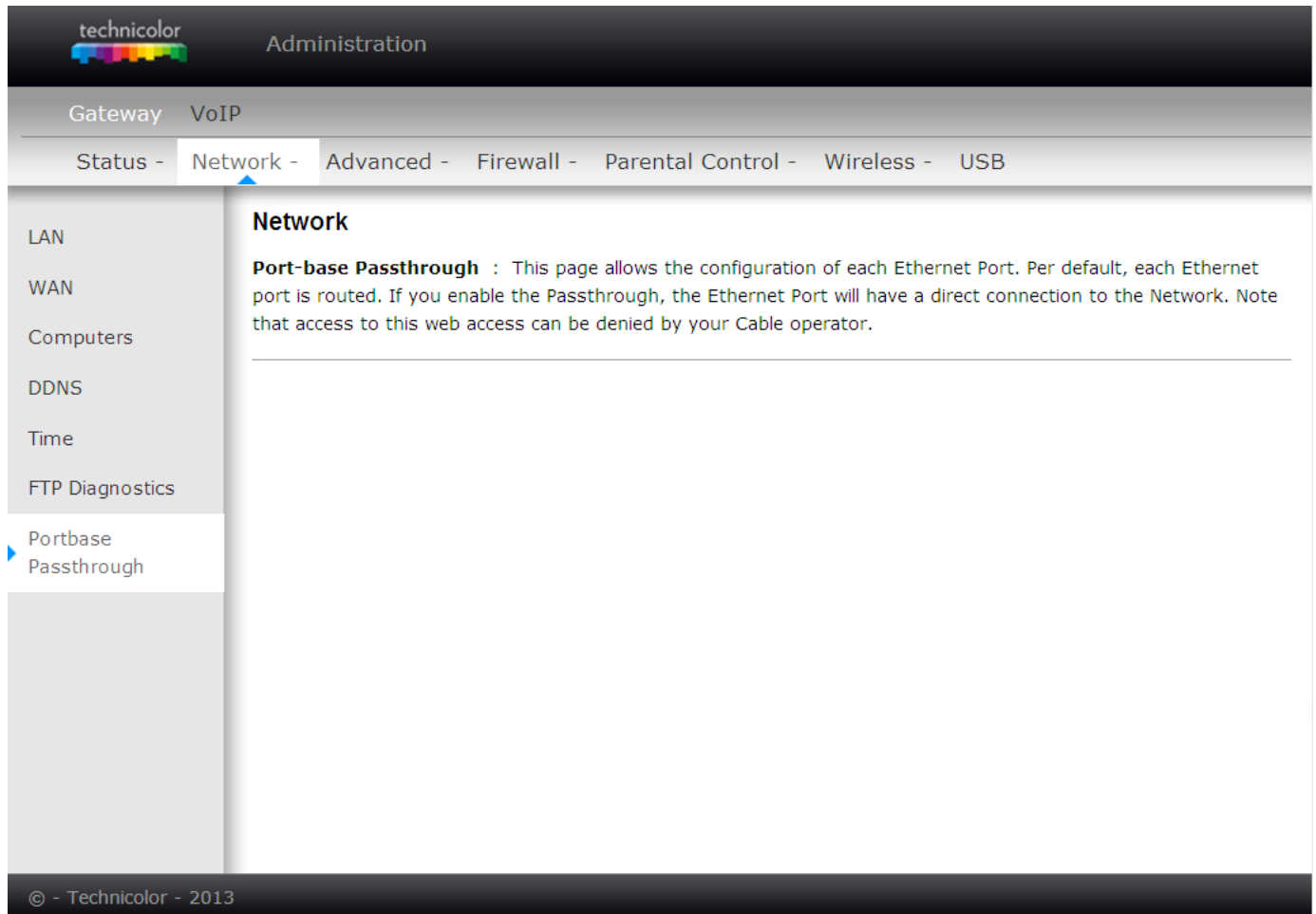

Fig.2-20 Gateway\Network\ Port-base Passthrough

Gateway – Advanced Web Page Group

Options

This page allows you to enable/disable some features of the Wireless Voice Gateway.

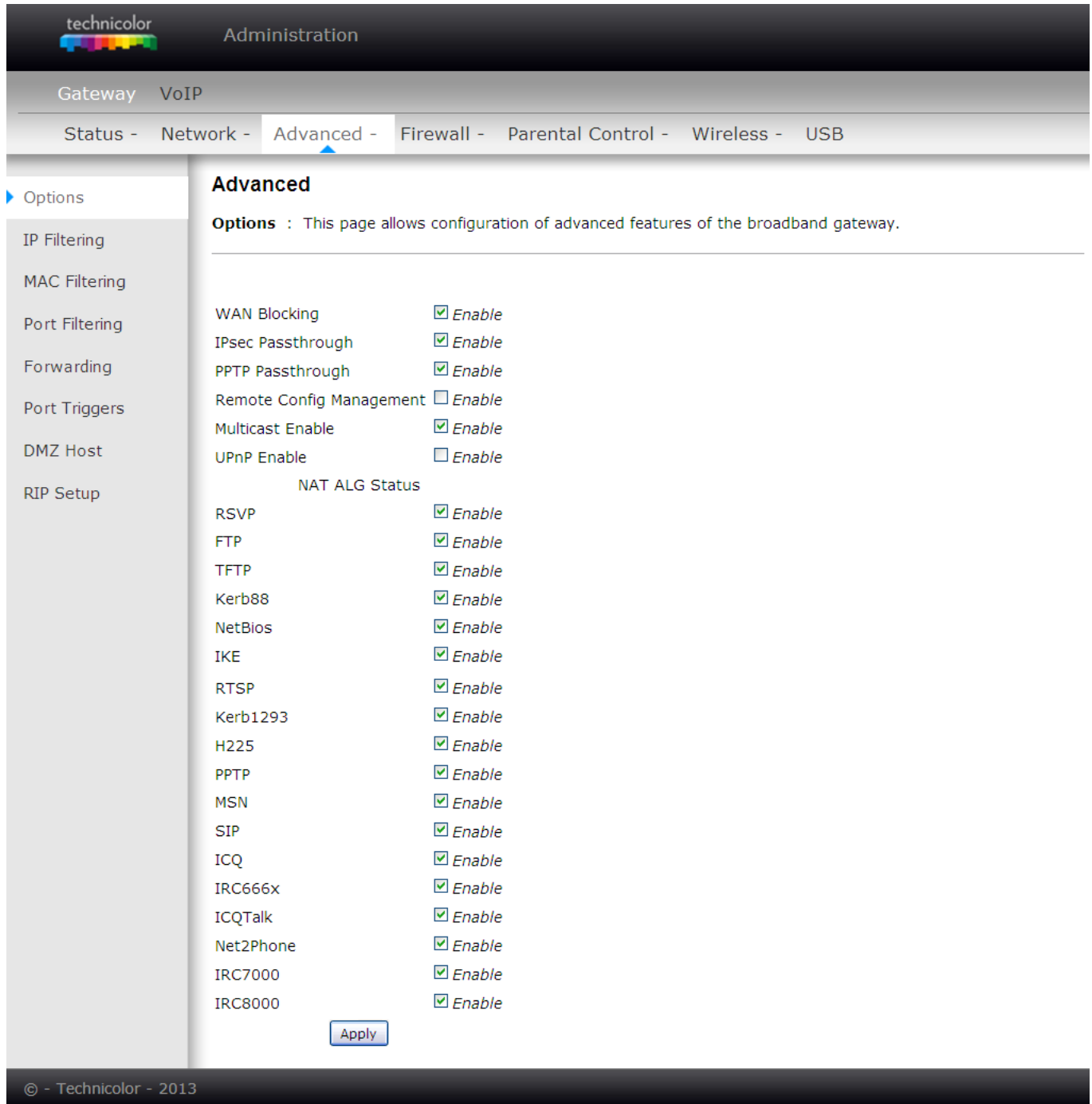

Fig.2-21 Gateway\Advanced\Options

- **WAN Blocking** prevents others on the WAN side from being able to ping your gateway. With WAN Blocking enabled, your gateway will not respond to pings it receives, effectively “hiding” your gateway.
- **Ipsec PassThrough** enables IpSec type packets to pass WAN ⇔ LAN. IpSec (IP Security) is a security mechanism used in Virtual Private Networks (VPNs).



- **PPTP PassThrough** enables PPTP type packets to pass WAN ⇔ LAN. PPTP (Point to Point Tunneling Protocol) is another mechanism sometimes used in VPNs.
- **Remote Config Management** makes the configuration web pages in your gateway accessible from the WAN side. Note that page access is limited to only those who know the gateway access password. When accessing your gateway from a remote location, you must use HTTP port 8080 and the WAN IP address of the gateway. e.g., if the WAN IP address is *157.254.5.7*, you would navigate to *http://157.254.5.7:8080* to reach your gateway.
- **Multicast Enable** enables multicast traffic to pass WAN⇔ LAN. You may need to enable this to see some types of broadcast streaming and content on the Internet.
- **UPnP** Universal Plug and Play (UPnP) helps devices, such as Internet appliances and computers, access the network and connect to other devices as needed. UPnP devices can automatically discover the services from other registered UPnP devices on the network.
- **NAT ALG** enable NAT ALG (application layer gateways) allows customized NAT traversal filters to be plugged into the gateway to support address and port translation for certain application layer "control/data" protocols such as RSVP, FTP, TFTP, Kerb88, NetBios , IKE, RTSP, Kerb1293 , H225 , PPTP , MSN , SIP , ICQ , IRC666x , ICQTalk , Net2Phone , IRC7000 , IRC8000 file transfer in IM applications etc. In order for these protocols to work through NAT or a firewall, either the application has to know about an address/port number combination that allows incoming packets, or the NAT has to monitor the control traffic and open up port mappings (firewall pinhole) dynamically as required. Legitimate application data can thus be passed through the security checks of the firewall or NAT that would have otherwise restricted the traffic for not meeting its limited filter criteria.



IP Filtering

This page enables you to enter the IP address ranges of PCs on your LAN that you don't want to have outbound access to the WAN. These PCs can still communicate with each other on your LAN, but packets they send to WAN addresses are blocked by the gateway.

The screenshot shows the Technicolor Gateway Administration interface. The top navigation bar includes 'Gateway' and 'VoIP'. Below it, a menu shows 'Status - Network - Advanced - Firewall - Parental Control - Wireless - USB', with 'Advanced' selected. On the left, a sidebar lists 'Options' such as 'IP Filtering', 'MAC Filtering', 'Port Filtering', 'Forwarding', 'Port Triggers', 'DMZ Host', and 'RIP Setup'. The main content area is titled 'Advanced' and contains the 'IP Filtering' section. A description states: 'IP Filtering : This page allows the configuration of IP Address filters in order to block internet traffic to specific network devices on the LAN.' Below this is a table for configuring filters:

IP Filtering		
Start Address	End Address	Enabled
192.168.0.0	192.168.0.0	<input type="checkbox"/>
192.168.0.0	192.168.0.0	<input type="checkbox"/>
192.168.0.0	192.168.0.0	<input type="checkbox"/>
192.168.0.0	192.168.0.0	<input type="checkbox"/>
192.168.0.0	192.168.0.0	<input type="checkbox"/>
192.168.0.0	192.168.0.0	<input type="checkbox"/>
192.168.0.0	192.168.0.0	<input type="checkbox"/>
192.168.0.0	192.168.0.0	<input type="checkbox"/>
192.168.0.0	192.168.0.0	<input type="checkbox"/>
192.168.0.0	192.168.0.0	<input type="checkbox"/>

Below the table is an 'Apply' button. At the bottom left of the interface, the copyright notice reads '© - Technicolor - 2013'.

Fig.2-22 Gateway\Advanced\IP Filtering



MAC Filtering

This page enables you to enter the MAC address of specific PCs on your LAN that you do not wish to have outbound access to the WAN. As with IP filtering, these PCs can still communicate with each other through the gateway, but packets they send to WAN addresses are blocked.

The screenshot shows the Technicolor Gateway Administration interface. At the top, there is a navigation bar with 'Gateway' and 'VoIP' tabs. Below this is a menu with 'Status', 'Network', 'Advanced', 'Firewall', 'Parental Control', 'Wireless', and 'USB'. The 'Advanced' tab is selected. On the left side, there is a sidebar menu with 'Options', 'IP Filtering', 'MAC Filtering' (highlighted with a blue arrow), 'Port Filtering', 'Forwarding', 'Port Triggers', 'DMZ Host', and 'RIP Setup'. The main content area is titled 'Advanced' and contains a description of 'MAC Filtering': 'This page allows the configuration of MAC Address filters in order to block internet traffic to specific network devices on the LAN.' Below the description is a section titled 'MAC Address Filters' with two columns of input fields. Each field is labeled 'MAC 01' through 'MAC 20' and contains six boxes for entering hexadecimal digits, all currently set to '00'. An 'Apply' button is located at the bottom right of the filter list.

Fig.2-23 Gateway\Advanced\MAC Filtering



Port Filtering

This page allows you to enter ranges of destination ports (applications) that you don't want your LAN PCs to send packets to. Any packets your LAN PCs send to these destination ports will be blocked. For example, you could block access to worldwide web browsing (http = port 80) but still allow email service (SMTP port 25 and POP-3 port 110). To enable port filtering, set Start Port and End Port for each range, and click Apply. To block only one port, set both Start and End ports with the same value.

The screenshot shows the Technicolor Administration interface. The top navigation bar includes 'Gateway' and 'VoIP'. Below it, a menu bar contains 'Status - Network - Advanced - Firewall - Parental Control - Wireless - USB', with 'Advanced' selected. On the left, a sidebar lists various configuration options: 'Options', 'IP Filtering', 'MAC Filtering', 'Port Filtering' (highlighted with a blue arrow), 'Forwarding', 'Port Triggers', 'DMZ Host', and 'RIP Setup'. The main content area is titled 'Advanced' and contains a section for 'Port Filtering'. A descriptive text states: 'Port Filtering : This page allows the configuration of port filters in order to block specific internet services to all devices on the LAN.' Below this is a table with the following structure:

Start Port	End Port	Protocol	Enabled
1	65535	Both	<input type="checkbox"/>
1	65535	Both	<input type="checkbox"/>
1	65535	Both	<input type="checkbox"/>
1	65535	Both	<input type="checkbox"/>
1	65535	Both	<input type="checkbox"/>
1	65535	Both	<input type="checkbox"/>
1	65535	Both	<input type="checkbox"/>
1	65535	Both	<input type="checkbox"/>
1	65535	Both	<input type="checkbox"/>
1	65535	Both	<input type="checkbox"/>

Below the table is an 'Apply' button. At the bottom left of the interface, the copyright notice reads '© - Technicolor - 2013'.

Fig.2-24 Gateway\Advanced\Port Filtering

For example :

To block HTTP (port 80) browse and restrict mail send from POP-3(port 110), setting as following

Port Filtering			
Start Port	End Port	Protocol	Enabled
80	80	Both <input type="button" value="v"/>	<input checked="" type="checkbox"/>
110	110	Both <input type="button" value="v"/>	<input checked="" type="checkbox"/>
1	65535	Both <input type="button" value="v"/>	<input type="checkbox"/>
1	65535	Both <input type="button" value="v"/>	<input type="checkbox"/>
1	65535	Both <input type="button" value="v"/>	<input type="checkbox"/>
1	65535	Both <input type="button" value="v"/>	<input type="checkbox"/>
1	65535	Both <input type="button" value="v"/>	<input type="checkbox"/>
1	65535	Both <input type="button" value="v"/>	<input type="checkbox"/>
1	65535	Both <input type="button" value="v"/>	<input type="checkbox"/>
1	65535	Both <input type="button" value="v"/>	<input type="checkbox"/>
1	65535	Both <input type="button" value="v"/>	<input type="checkbox"/>

Fig.2-25 Gateway\Advanced\Port Filtering

Setting port value, block protocol (Both for TCP & UDP), check 'Enable' then apply.



Forwarding

For LAN ↔ WAN communications, the gateway normally only allows you to originate an IP connection with a PC on the WAN; it will ignore attempts of the WAN PC to originate a connection onto your PC. This protects you from malicious attacks from outsiders. However, sometimes you may wish for anyone outside to be able to originate a connection to a particular PC on your LAN if the destination port (application) matches one you specify.

The screenshot shows the Technicolor Gateway Administration interface. The top navigation bar includes 'Gateway' and 'VoIP'. Below it, a menu shows 'Status - Network - Advanced - Firewall - Parental Control - Wireless - USB', with 'Advanced' selected. A left sidebar lists various settings: Options, IP Filtering, MAC Filtering, Port Filtering, Forwarding (highlighted), Port Triggers, DMZ Host, and RIP Setup. The main content area is titled 'Advanced' and contains a 'Forwarding' section with a descriptive paragraph and two buttons: 'Create IPv4' and 'Create IPv6'. Below these is a 'Port Forwarding' table with columns for Internal and External IP addresses, ports, protocols, descriptions, and an 'Enabled' checkbox. A 'Remove All' button is also present. At the bottom, there is an 'UPNP port mapping' section with a table header for Protocol, Start Port, End Port, and Description. The footer of the interface reads '© - Technicolor - 2013'.

Fig.2-26 Gateway\Advanced\Forwarding



Press ‘Create Ipv4’ button you will see follow options shows on the page. To specify rules, choose **Service Name** or **Port** number range to set up. IP Address 0.0.0.0 means allow all IP address.

Known Rule Adder

Local IP Address:

External IP Address:

Service Name: ▼

Local IP Address

Local Start Port

Local End Port

External IP

External Start Port

External End Port

Protocol ▼

Description

Enabled ▼

Fig.2-27 Gateway\Advanced\Forwarding setting

This page allows you to specify up to rules. For example, to specify that outsiders should have access to an FTP server you have running at 192.168.0.5, create a rule with that address and Start Port =20 and End Port =21 (FTP port ranges) and Protocol = TCP (FTP runs over TCP and the other transport protocol, UDP), and click Apply. This will cause inbound packets that match to be forwarded to that PC rather than blocked. As these connections are not tracked, no entry is made for them in the Connection Table. The same IP address can be entered multiple times with different ports.



Press ‘Create Ipv6’ button you will see follow options shows on the page. To specify rules, choose **Service Name** or **Port** number range to set up. IP Address 0.0.0.0 means allow all IP address.

Known Rule Adder

Local IP Address:

External IP Address:

Service Name: ▼

Local IP Address

Local Start Port

Local End Port

External IP

Protocol ▼

Description

Enabled ▼

Fig.2-28 Gateway\Advanced\Forwarding setting

This page allows you to specify up to rules. For example, to specify that outsiders should have access to an FTP server you have running at 192.168.0.5, create a rule with that address and Start Port =20 and End Port =21 (FTP port ranges) and Protocol = TCP (FTP runs over TCP and the other transport protocol, UDP), and click Apply. This will cause inbound packets that match to be forwarded to that PC rather than blocked. As these connections are not tracked, no entry is made for them in the Connection Table. The same IP address can be entered multiple times with different ports.



Port Triggers

Some Internet activities, such as interactive gaming, require that a PC on the WAN side of your gateway be able to originate connections during the game with your game playing PC on the LAN side. You could use the Advanced-Forwarding web page to construct a forwarding rule during the game, and then remove it afterwards (to restore full protection to your LAN PC) to facilitate this. Port triggering is an elegant mechanism that does this work for you, each time you play the game.

The screenshot shows the Technicolor Gateway Administration interface. The top navigation bar includes 'Gateway' and 'VoIP'. Below it, a menu bar contains 'Status - Network - Advanced - Firewall - Parental Control - Wireless - USB', with 'Advanced' selected. On the left, a sidebar lists various configuration options: Options, IP Filtering, MAC Filtering, Port Filtering, Forwarding, Port Triggers (highlighted with a blue arrow), DMZ Host, and RIP Setup. The main content area is titled 'Advanced' and contains a description of Port Triggers: 'Port Triggers : This page allows configuration of dynamic triggers to specific devices on the LAN. This allows for special applications that require specific port numbers with bi-directional traffic to function properly. Applications such as video conferencing, voice, gaming, and some messaging program features require these special settings.' Below the text is a 'Create' button. A table titled 'Port Triggering' is displayed with the following structure:

Trigger Range		Target Range		Protocol	Description	Enable	Remove All
Start Port	End Port	Start Port	End Port				

At the bottom left of the interface, the copyright notice reads '© - Technicolor - 2013'.

Fig.2-29 Gateway\Advanced\Port Triggers



Press 'Create' button to specify rules.

Trigger Start Port	<input type="text" value="0"/>
Trigger End Port	<input type="text" value="0"/>
Target Start Port	<input type="text" value="0"/>
Target End Port	<input type="text" value="0"/>
Protocol	<input type="text" value="BOTH"/>
Description	<input type="text"/>
Enabled	<input type="text" value="Off"/>

Fig.2-30 Gateway\Advanced\Port Triggers

Port Triggering works as follows. Imagine you want to play a particular game with PCs somewhere on the Internet. You make one time effort to set up a Port Trigger for that game, by entering into **Trigger Start Port** and **Tigger End Port** the range of destination ports your game will be sending to, and entering into **Target Start Port** the range of destination ports the other player (on the WAN side) will be sending to (ports your PC's game receives on). Application programs like games publish this information in user manuals. Later, each time you play the game, the gateway automatically creates the forwarding rule necessary. This rule is valid until 10 minutes after it sees game activity stop. After 10 minutes, the rule becomes inactive until the next matched outgoing traffic arrives.

e.g., suppose you specify Trigger Range from 6660 to 6670 and Target Range from 113 to 113. An outbound packet arrives at the gateway with your game-playing PC source IP address 192.168.0.10, destination port 666 over TCP/IP. This destination port is within the Trigger destined for port 113 to your game-playing PC at 192.168.0.10.



DMZ Host

Use this page to designate one PC on your LAN that should be left accessible to all PCs from the WAN side, for all ports. e.g., if you put an HTTP server on this machine, anyone will be able to access that HTTP server by using your gateway IP address as the destination. A setting of “0” indicates NO DMZ PC. “Host” is another Internet term for a PC connected to the Internet.

The screenshot shows the Technicolor Gateway Administration interface. At the top, there is a navigation bar with the Technicolor logo and the word "Administration". Below this is a secondary navigation bar with tabs for "Gateway" and "VoIP". A third navigation bar contains menu items: "Status -", "Network -", "Advanced -", "Firewall -", "Parental Control -", "Wireless -", and "USB". The "Advanced" menu item is selected and highlighted with a blue triangle. On the left side, there is a vertical sidebar with a list of options: "Options", "IP Filtering", "MAC Filtering", "Port Filtering", "Forwarding", "Port Triggers", "DMZ Host" (which is selected and has a blue arrow), and "RIP Setup". The main content area is titled "Advanced" and contains the following text: "DMZ Host (Exposed Host) : This page allows configuration of a specific network device to be exposed or visible directly to the WAN (Public Internet). This may be used when problem applications do not work with port triggers. Entering a "0" means there are no exposed hosts." Below this text is a form field labeled "DMZ Address" with the value "192.168.0.0" entered. An "Apply" button is located below the form field. At the bottom of the page, there is a footer that reads "© - Technicolor - 2013".

Fig.2-31 Gateway\Advanced\DMZ Host



RIP (Routing Information Protocol) Setup

This feature enables the gateway to be used in small business situations where more than one LAN (local area network) is installed. The RIP protocol provides the gateway a means to “advertise” available IP routes to these LANs to your cable operator, so packets can be routed properly in this situation.

Your cable operator will advise you during installation if any setting changes are required here.

The screenshot shows the Technicolor Gateway Administration interface. At the top, there is a navigation bar with the Technicolor logo and the word "Administration". Below this, there are tabs for "Gateway" and "VoIP". Under the "Gateway" tab, there are sub-tabs: "Status", "Network", "Advanced" (which is selected), "Firewall", "Parental Control", "Wireless", and "USB".

On the left side, there is a sidebar menu with the following items: "Options", "IP Filtering", "MAC Filtering", "Port Filtering", "Forwarding", "Port Triggers", "DMZ Host", and "RIP Setup" (which is highlighted with a blue arrow).

The main content area is titled "Advanced" and contains the "Routing Information Protocol Setup" section. The text below the title reads: "This page allows configuration of RIP parameters related to authentication, destination IP address/subnet mask, and reporting intervals. RIP automatically identifies and uses the best known and quickest route to any given destination address."

The configuration fields are as follows:

- RIP Support: Disabled (dropdown menu)
- RIP Authentication: Enable
- RIP Authentication Key:
- RIP Authentication Key ID:
- RIP Reporting Interval: seconds
- RIP Destination IP Address: . . .

At the bottom of the configuration area, there is an "Apply" button.

At the bottom left of the page, there is a copyright notice: "© - Technicolor - 2013".

Fig.2-32 Gateway\Advanced\RIP Setup

Gateway – Firewall Web Page Group

Web Content Filtering

These pages allow you to enable, disable, and configure a variety of firewall features associated with web browsing, which uses the HTTP protocol and transports HTML web pages. On these pages, you designate the gateway packet types you want to have forwarded or blocked. You can activate settings by checking them and clicking Apply.

The web-related filtering features you can activate from the Web Content Filter page include Filter Proxy, Filter Cookies, Filter Java Applets, Filter ActiveX, Filter Popup Windows, and Firewall Protection.

If you want the gateway to exclude your selected filters to certain computers on your LAN, enter their MAC addresses in the Trusted Computers area of this page.

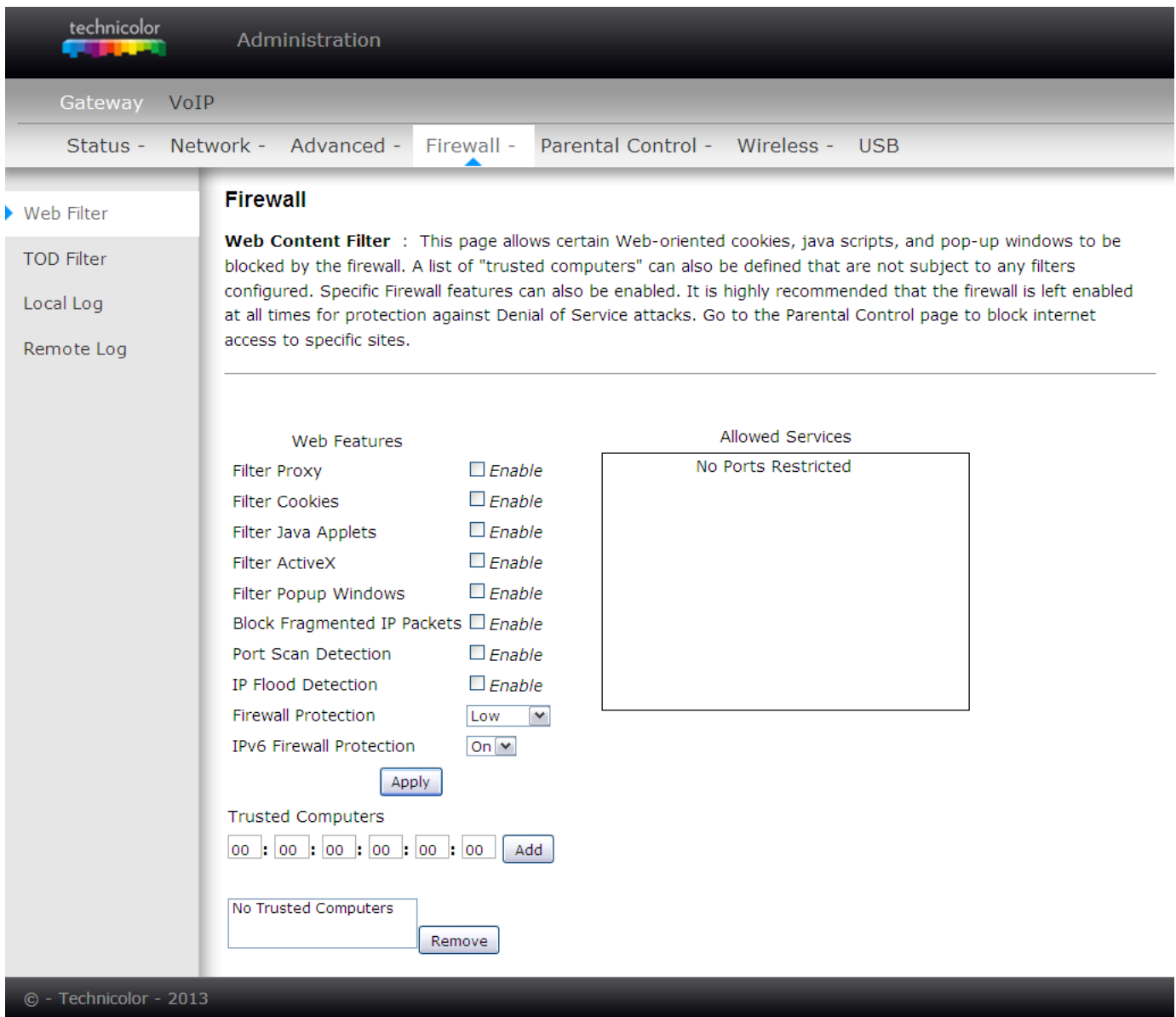

Fig.2-33 Gateway\Firewall\Web Filter



TOD Filtering

Use this page to set rules that will block specific LAN side PCs from accessing the Internet, but only at specific days and times. Specify a PC by its hardware MAC address, and then use the tools to specify blocking time. Finally, click the Apply button to save your settings.

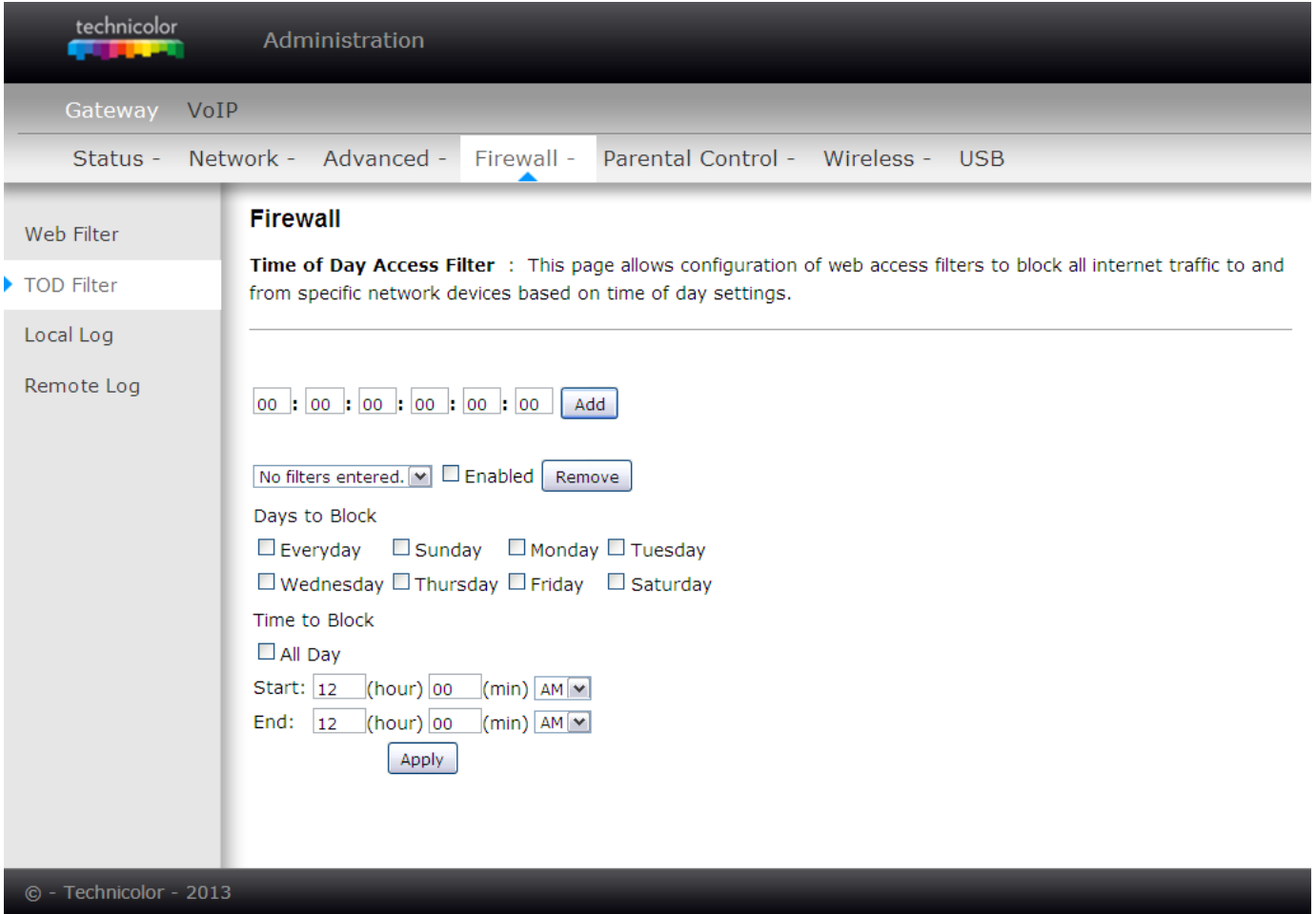

Fig.2-34 Gateway\Firewall\TOD Filtering



Local Log

The gateway builds a log of firewall blocking actions that the firewall has taken. Using the Local Log page lets you specify an email address to which you want the gateway to email this log. You must also tell the gateway your outgoing (i.e. SMTP) email server's name, so it can direct the email to it. Enable Email Alerts has the gateway forward email notices when Firewall protection events occur. Click **E-mail Log** to immediately send the email log. Click **Clear Log** to clear the table of entries for a fresh start.

The log of these events is also visible on the screen. For each blocking event type that has taken place since the table was last cleared, the table shows Description, Count, Last Occurrence, Target, and Source.

The screenshot shows the Technicolor Administration interface. The top navigation bar includes 'Gateway' and 'VoIP'. Below it, a menu bar contains 'Status - Network - Advanced - Firewall - Parental Control - Wireless - USB', with 'Firewall' selected. On the left, a sidebar lists 'Web Filter', 'TOD Filter', 'Local Log' (selected), and 'Remote Log'. The main content area is titled 'Firewall' and contains the following text: 'Local Log : This page allows configuration of Firewall event log reporting via email alerts and a local view of the attacks on the system.' Below this text are several input fields: 'Contact Email Address', 'SMTP Server Name', 'SMTP Username', and 'SMTP Password'. There is also a checkbox for 'E-mail Alerts' with the label 'Enable' and an 'Apply' button. At the bottom of the configuration area, there are two buttons: 'E-mail Log' and 'Clear Log'. Below the buttons is a table header with five columns: 'Description', 'Count', 'Last Occurrence', 'Target', and 'Source'. The footer of the page reads '© - Technicolor - 2013'.

Fig.2-35 Gateway\Firewall\Local Log



Remote Log

The Remote Log page allows you to specify the IP address where a SysLog server is located on the LAN Side and select different types of firewall events that may occur. Then, each time such an event occurs, notification is automatically sent to this log server.

The screenshot shows the Technicolor Administration web interface. At the top, there is a navigation bar with the Technicolor logo and the word "Administration". Below this, there are tabs for "Gateway" and "VoIP". A secondary navigation bar contains links for "Status", "Network", "Advanced", "Firewall", "Parental Control", "Wireless", and "USB". The "Firewall" tab is selected, and a sub-menu on the left lists "Web Filter", "TOD Filter", "Local Log", and "Remote Log" (which is highlighted with a blue arrow). The main content area is titled "Firewall" and contains a section for "Remote Log" with the following text: "Remote Log : This page allows optional configuration of events to be sent to a local SysLog Server." Below this, there is a heading "Send selected events" followed by four unchecked checkboxes: "Permitted Connections", "Blocked Connections", "Known Internet Attacks", and "Product Configuration Events". Underneath these checkboxes, it says "to Syslog Server at 192.168.0." followed by a text input field containing "0". An "Apply" button is located below the input field. At the bottom left of the interface, there is a copyright notice: "© - Technicolor - 2013".

Fig.2-36 Gateway\Firewall\Remote Log

Gateway – Parental Control Web Page Group

Basic

This page allows you to enable, disable, and configure a variety of firewall features associated with web browsing, which uses the HTTP protocol and transports HTML web pages. On these pages, you designate the gateway packet types you want to have forwarded or blocked. You can activate settings by checking them and clicking Apply.

Here are some of your choices on the Parental Control page:

- Activate **Keyword Blocking** and specify some keywords in the Keyword List to cause blocking of web pages on the WAN side with the specified keyword in the content.
- Activate **Domain Blocking** and specify some Domain Names (e.g. www.ABC.com) in the Domain List.

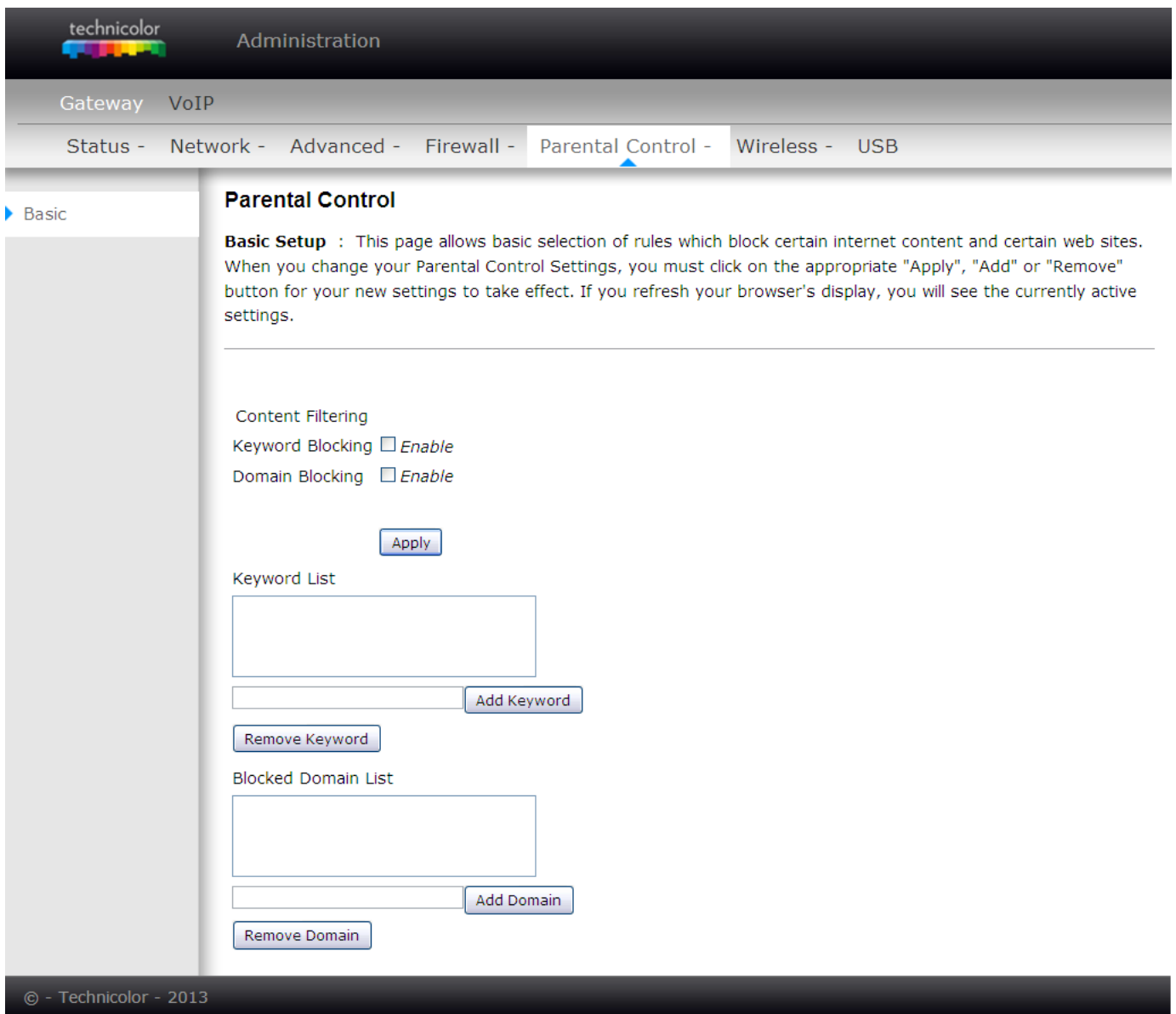

Fig.2-37 Gateway\Parental Control\Basic



Gateway – Wireless Web Page Group

The Wireless web pages group enables a variety of settings that can provide secure and reliable wireless communications for even the most demanding tech-savvy user.

The Wireless Voice Gateway offers a choice of 802.11b/g/n, WPA and WPA-PSK authentication of your PCs to the gateway, 64 and 128 bit WEP encryption of communication between the gateway and your PCs to guaranty security, and an Access Control List function that enables you to restrict wireless access to only your specific PCs.

Performance

Because your wireless communication travels through the air, the factory default wireless channel setting may not provide optimum performance in your home if you or your neighbors have other interfering 2.4GHz or 5 GHz devices such as cordless phones. If your wireless PC is experiencing very sluggish or dramatically slower communication compared with the speed you achieve on your PC that is wired to the gateway, try changing the channel number. See the 802.11b/g/n Basic Web Page discussion below for details.

Authentication

Authentication enables you to restrict your gateway from communicating with any remote wireless PCs that aren't yours. The following minimum authentication-related changes to factory defaults are recommended. See the 802.11b/g/n Basic and Access Control Web Page discussions below for details.

Network Name (SSID) – Set a unique name you choose

Network Type – Set to Open

Access Control List – Enter your wireless PCs' MAC addresses

Security

Security secures or scrambles messages traveling through the air between your wireless PCs and the gateway, so they can't be observed by others. The following minimum security setting changes to factory defaults are recommended. See the 802.11b/g/n Security Web Page discussion below for details.



Radio

To set the basic configuration for the wireless features, click RADIO from the Wireless menu. These must match the settings you make on your wireless-equipped PC on the LAN side.

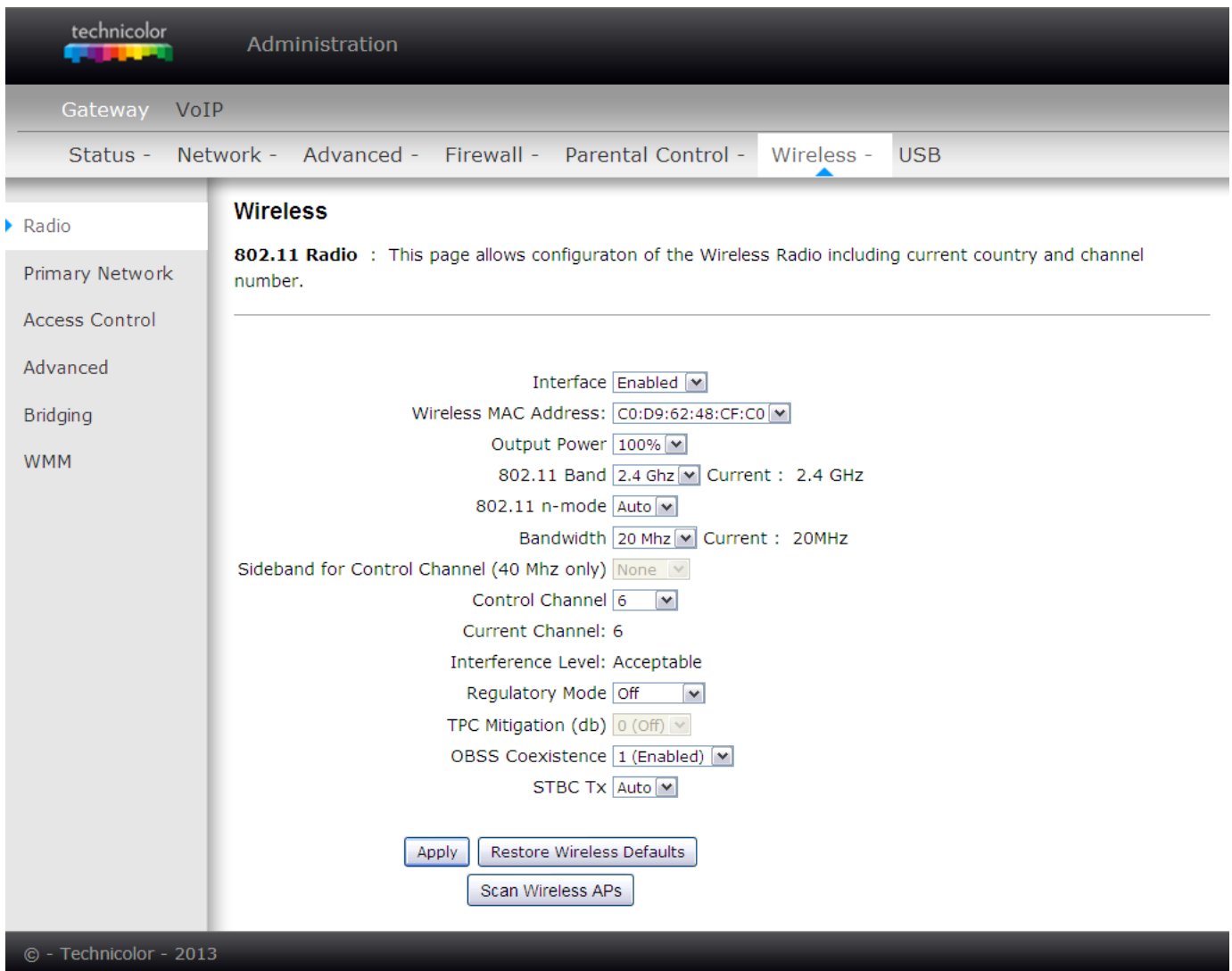

Fig.2-38 Gateway\Wireless\Radio

- **Interface:** The wireless radio in your gateway can be completely de-activated by changing **Interface** to Disabled. Click the **Apply** button to save your settings. Activated by changing interface to enabled
- **Wireless MAC Address:** The MAC address for this wireless device will be displayed in this field automatically.
- **Output Power:** This setting decides the output power of this device. You may use it to economize on electricity by selecting lower percentage of power output. Control the range of the AP by adjusting the radio output power.
- **802.11 Band:** It Support 2.4 GHz and 5 GHz band. This default band was 2.4 GHz.
- **802.11 n-mode:** It may help you to **Enable** or **Disable** the 11N mode. To enable you need to select **Auto**, to disable you need to select **Off**, and so force the AP to operate in 802.11 n-mode.
- **Bandwidth:** Select wireless channel width **20 MHz** is for default value (bandwidth taken by wireless signals of this access point.)



- **Sideband for Control Channel (40 MHz only):** There is “Lower” and “Upper” can be selected if Bandwidth 40 MHz was Enabled.
- **Control Channel:** In 802.11 Band 2.4GHz, there are 1 to 13 channels. In 802.11 Band 5GHz, there are 36, 40, 44, 48 total 4 channels for all country. Choose the one that is suitable for this device.
- **Current Channel:** The channel that you choose will be displayed in this field.
- **Regulatory Mode:** suppose 802.11d and 802.11h to satisfy specific environment and request.
- **TPC Mitigation (db):** Fixed Maximum TX Power Level, options 0 ~ 4 db
- **OBSS Coexistence:** Overlapping BBS coexistence, here to control this function Enable or Disable, default was enabled.
- **STBC Tx:** Space–time block coding is a technique used in wireless communications to transmit multiple copies of a data stream across a number of antennas and to exploit the various received versions of the data to improve the reliability of data-transfer. Default was “Auto”.
- **Restore Wireless defaults:** To recover to the default settings, press this button to retrieve the settings then click Apply.

Setting	Description	Value List or Range	Default
Network Name (SSID)	Set the Network Name (also known as SSID) of this network.	Up to 32-character string containing ASCII characters only	PExxx
Network Type	Select Closed to hide the network from active scans. Select Open to reveal the network to active scans.	Open, Closed	Open
New Channel	Select a particular channel on which to operate.	1-13	1 or 6 or 11
Interface	Enable or disable the wireless interface.	Enabled, Disabled	Enabled

Table. 2-1 Basic Settings Definitions



Primary Network

This page allows you to configure the Network Authentication. It provides several different modes of wireless security. You will have to enter proper information according to the mode you select.

The screenshot shows the 'Administration' interface for a Technicolor device. The navigation menu includes Gateway, VoIP, Status, Network, Advanced, Firewall, Parental Control, Wireless (selected), and USB. The left sidebar lists Radio, Primary Network (selected), Access Control, Advanced, Bridging, and WMM. The main content area is titled 'Wireless' and contains the following configuration options:

- Primary Network PE666 (c0:d9:62:48:cf:c0)**
 - Primary Network: Enabled
 - Network Name (SSID):
 - Closed Network: Open
 - AP Isolate: Disabled
 - WPA Enterprise: Disabled
 - WPA-PSK: Disabled
 - WPA2 Enterprise: Disabled
 - WPA2-PSK: Disabled
- Automatic Security Configuration**
 - WPS: WPS
 - WPS Config State: Configured
 - The physical button on the AP will provision wireless clients using Wi-Fi Protected Setup (WPS)
 - Device Name:
- WPS Setup AP**
 - UUID: d0bd5b5150d1fcca12802a3be34a58bd
 - PIN:
- WPS Add Client**
 - Add a client:
 - Client PIN:
 - Authorized Client MAC:
- WPA/WPA2 Encryption: Disabled
- WPA Pre-shared Key: Show Key
- RADIUS Server:
- RADIUS Port:
- RADIUS Key:
- Group Key Rotation Interval:
- WPA/WPA2 Re-auth Interval:
- WEP Encryption: Disabled
- Shared Key Authentication: Optional
- 802.1x Authentication: Disabled
- Network Key 1:
- Network Key 2:
- Network Key 3:
- Network Key 4:
- Current Network Key: 1
- Passphrase:
-
-

Fig. 2-39 Gateway\Wireless\Primary Network



802.11x Authentication introduction

If you enable the **802.11x authentication** function, you will have to offer the following information-

- **WPA (Wi-Fi Protected Access)/WPA2:**
It must be used in conjunction with an authentication server such as RADIUS to provide centralized access control and management. It can provide stronger encryption and authentication solution than none WPA modes. **WPA2** is the second generation of **WPA** security.
- **WPA-PSK (WPA-Pre-Shared Key) /WPA2-PSK (WPA2-Pre-Shared Key):**
It is useful for small places without authentication servers such as the network at home. It allows the use of manually-entered keys or passwords and is designed to be easily set up for home users.
- **RADIUS Server:** RADIUS Server is a protocol for carrying authentication, authorization, and configuration information between a Network Access Server which desires to authenticate its links and a shared Authentication Server. Please key in the IP Address for the RADIUS Server.
- **RADIUS Port:** Besides the IP address of the RADIUS Server, you have to enter the port number for the server. Port 1812 is the reserved RADIUS-authentication port described in RFC 2138. Earlier AP (RADIUS clients) use port 1945. The default value will be shown on this box. You can keep and use it.
- **RADIUS Key:** A RADIUS Key is like a password, which is used between IAS and the specific RADIUS client to verify identity. Both IAS and the RADIUS client must be use the same RADIUS Key for successful communication to occur. Enter the RADIUS Key.



■ **WPA/WPA2:**

For the WPA/WPA2 network Authentication, the settings that you can adjust including WPA/WPA2 Encryption, RADIUS Server, RADIUS Port, RADIUS Key, Group Key Rotation Interval, and WPA/WPA2 Re-auth Interval.

● **WPA/WPA2 Encryption:**

There are two types that you can choose, **AES**, **TKIP+AES**.

TKIP takes the original master key only as a starting point and derives its encryption keys mathematically from this mater key. Then it regularly changes and rotates the encryption keys so that the same encryption key will never be used twice

AES provides security between client workstations operating in ad hoc mode. It uses a mathematical ciphering algorithm that employs variable key sizes of 128, 192 or 256 bits.

● **RADIUS Server/RADIUS Port/RADIUS Key:**

Please refer to the previous page.

● **Group Key Rotation Interval:**

Key in the time for the WAP group key rotation interval. The unit is second. With increasing rekey interval, user bandwidth requirement is reduced.

● **WPA/WPA2 Re-auth Interval:**

When a wireless client has associated with the Wireless Voice Gateway for a period of time longer than the setting here, it would be disconnected and the authentication will be executed again. The default value is 3600, you may modify it.

WPA Enterprise

WPA-PSK

WPA2 Enterprise

WPA2-PSK

WPA/WPA2 Encryption

WPA Pre-shared Key

Show Key

RADIUS Server

RADIUS Port

RADIUS Key

Group Key Rotation Interval

WPA/WPA2 Re-auth Interval

Fig. 2-40 WPA/WPA2



■ **WPA-PSK/ WPA2-PSK:**

For the WPA-PSK/WPA2-PSK network Authentication, the settings that you can adjust including WPA/WPA2 Encryption, WPA Pre-Shared Key, and Group key Rotation Interval.

● **WPA Pre-Shared Key:**

Please type the key to be between 8 and 63 characters, or 64 hexadecimal digits. Only the devices with a matching key that you set here can join this network.

WPA Enterprise

WPA-PSK

WPA2 Enterprise

WPA2-PSK

WPA/WPA2 Encryption

WPA Pre-shared Key

Show Key

RADIUS Server

RADIUS Port

RADIUS Key

Group Key Rotation Interval

WPA/WPA2 Re-auth Interval

Fig. 2-41 WPA-PSK/WPA2-PSK



■ **WEP Encryption:**

You can choose **64-bit** or **128-bit** according to your needs. If you choose **Disabled**, the Network Keys will not be shown on this page. If selected, the data is encrypted using the key before being transmitted. e.g., If you set 128-bit in this field, then the receiving station must be set to use the 128 Bit Encryption, and have the same Key value too. Otherwise, it will not be able to decrypt the data.

(Note: You need to connect one end of the Ethernet cable to the Ethernet port on the back of your computer, and the other end to the ETHERNET port on the Wireless Voice Gateway.)

If you select WEP (**64-bit** or **128-bit**), you can adjust the following settings-

● **Shared Key Authentication:**

Decide whether to set the shared key **Optional** or **Required** by selecting from the drop-down menu.

● **Network Key 1 to 4:**

The system allows you to enter four sets of the WEP key. For **64-bit** WEP mode, the key length is 5 characters or 10 hexadecimal digits. As for **128-bit** WEP mode, the key length is 13 characters or 26 hexadecimal digits.

● **Current Network Key:**

Select one set of the network key (from 1 to 4) as the default one.

● **Passphrase:**

You can enter ASCII codes into this field. The range is from 8 characters to 64 characters. For **ASCII characters**, you can key in **63** characters in this field. If you want to key in **64** characters, only **hexadecimal characters** can be used.

● **Generate WEP Keys:**

Click this button to generate the Passphrase.

● **Apply:**

After proper configuration, click Apply to invoke the settings.

WEP Encryption

Shared Key Authentication

802.1x Authentication

Network Key 1

Network Key 2

Network Key 3

Network Key 4

Current Network Key

Passphrase

Fig. 2-42 WEP (64-bit) / WEP (128-bit)



Automatic Security Configuration

Wi-Fi Protected Setup™ (WPS) is an easy and secure way of configuring and connecting your Wireless access point. In this case, the Wireless Voice Gateway is the Access Point (AP), and Your PC (or Wireless Device) is called the STA. When configuring your Wireless Network via WPS, Messages are exchanged between the STA and AP in order to configure the Security Settings on both devices.

- **WPS Configuration:** It will help you to **Enable** or **Disable** the WPS feature. To enable you need to select **WPS**, to disable you need to select **Disabled**.

Note: After you **Enable** the WPS you will get the options as show in Fig.2-36 and the WPS Configuration State box will show its configuration status.

- **Device Name:** By using this you can change the factory default to a name of your choice which is up to 32 characters long as like **SSID**.
- **WPS Setup AP:** Here you do not need to change anything, just skip this step.
- **WPS Add Client:** There are two methods type “Client PIN” and “Authorized Client MAC”. Type in the client information you want. Then press button “add”.

Automatic Security Configuration

WPS

WPS Config State: Configured

The physical button on the AP will provision wireless clients using Wi-Fi Protected Setup (WPS)

Device Name

WPS Setup AP

UUID:d0bd5b5150d1fcca12802a3be34a58bd

PIN:

WPS Add Client

Add a client:

Client PIN:

Authorized Client MAC:

Fig. 2-43 Automatic Security Configuration



If you type in Client PIN, then the **WPS Add Client** option will appear as shown below.

WPS Add Client

Add a client:

Client PIN:

Authorized Client MAC:

Fig.2-44 WPS/Push-Button

And then if you click “**Add**” button then **WPS Add Client** page will appear as shown in Fig.38

WPS Add Client

Your AP is now waiting for the STA to connect.

WPS Configure Status: InProgress

Fig.2-45 WPS Setup AP/PUSH

And **WPS Configure Status** will be “In progress”, after establishing the connection the **WPS Configure Status** will be “Success!” as shown below. After successful connection the client will get IP address from AP and then internet will be accessible.

WPS Add Client SUCCESSFUL

Configuration is complete. Click 'Continue' to return to the previous page.

WPS Configure Status: Success!

Fig.2-46 WPS Setup AP successful/PUSH

WPS Add Client process also can finish with type in Authorized Client MAC.



Access Control

This page allows you to control device that can connect to the AP and list all connected clients. Control is made by Mac Address.

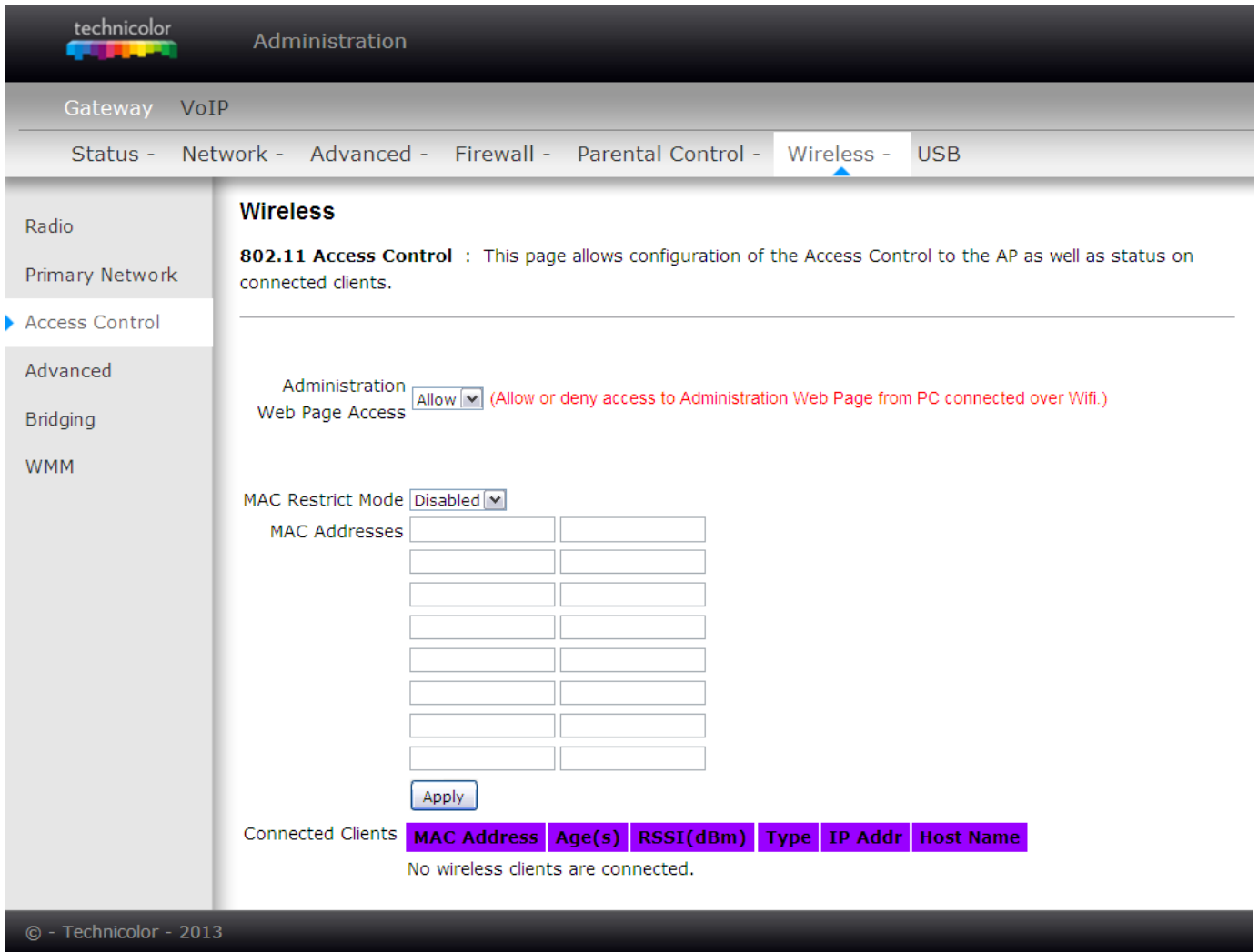

Fig. 2-47 Gateway\Wireless\Access Control

- **Administration Web Page Access:** This field let you decide if a PC connected over Wi-Fi to the Gateway can have access to the Gateway Web Pages.
- **MAC Restrict Mode:** Click **Disabled** to welcome all of the clients on the network; select **Allow** to permit only the clients on the list to access the cable modem; or choose **Deny** to prevent the clients on the list to access this device.
- **MAC Address:** Your Gateway identifies wireless PCs by their Wireless MAC Address. This address consists of a string of 6 pairs of numbers 0-9 and letters A-F, such as 00 90 4B F0 FF 50. It is usually printed on the Wireless card of the device (e.g. the PCMCIA card in a laptop).
- Enter the MAC addresses of the connected clients into the fields, and then click Apply to add them to the list for access control.
- **Apply:** After proper configuration, click Apply to invoke the settings.
- **Connected Clients:** The information of currently connected clients will be displayed here.



Advanced

This page allows you to configure some advanced settings. The factory default values should provide good results in most cases. We don't recommend you change these settings unless you have technical knowledge of 802.11 wireless technology.

For expert users, details of all settings on this web page are provided below.

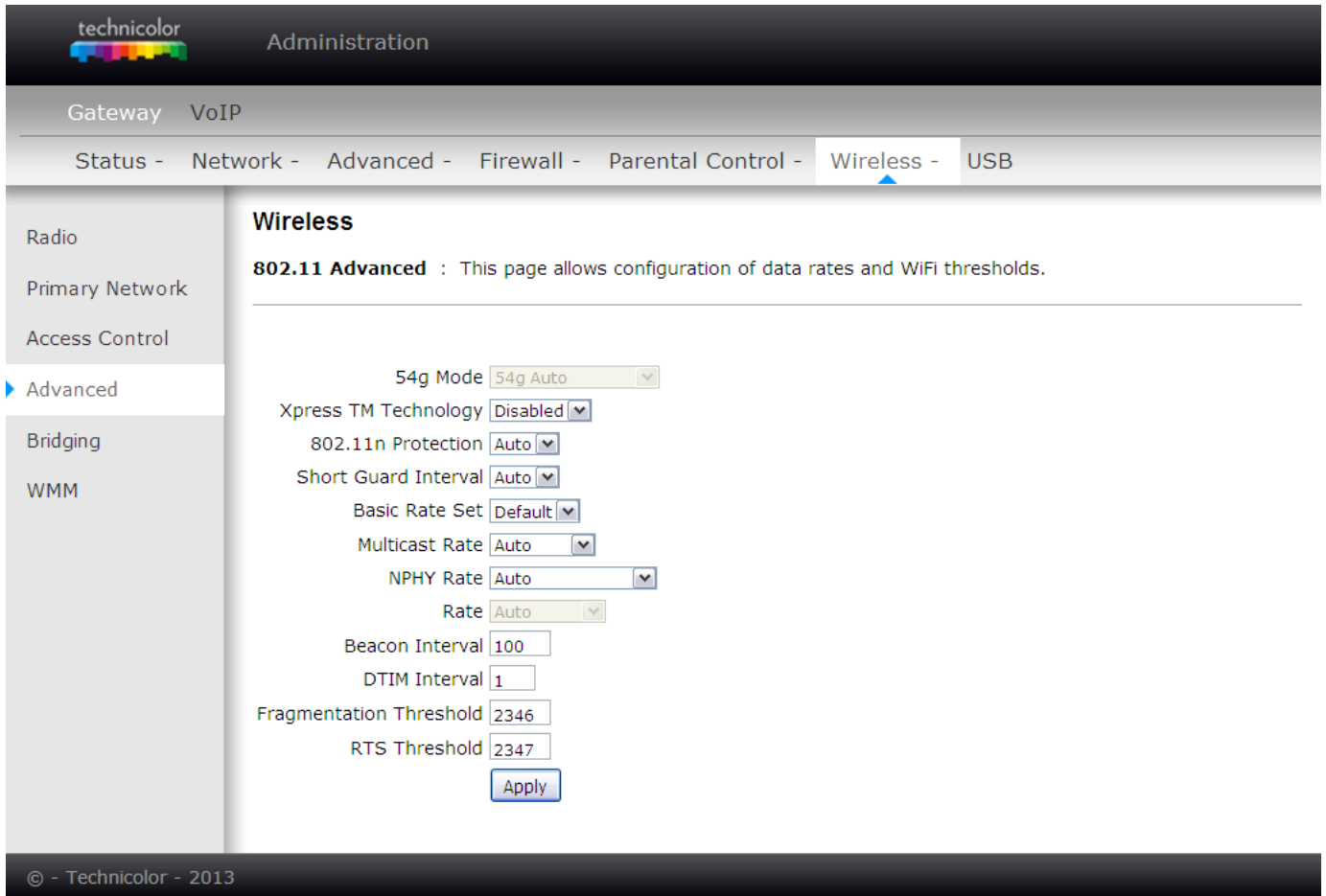

Fig. 2-48 Gateway\Wireless\Advanced

- **54™ Mode:** Except Auto mode, there are three modes for you choose, please check the specification of your wireless card and choose a proper setting.
- **Xpress™ Technology:** When Xpress is turned on, aggregate throughput (the sum of the individual throughput speeds of each client on the network) can improve by up to 27% in 802.11g-only networks, and up to 75% in mixed networks comprised of 802.11g and 802.11b standard equipment.
- **802.11n Protection:** This method provides 802.11g and 802.11b devices can co-exist in the same network without “speaking” at the same time. Default is “Auto”.
- **Short Guard Interval:** To reduce complexity, manufacturers typically only implement a short guard interval as a final rate adaptation step when the device is running at its highest data rate. Default is “Auto”.
- **Basic Rate Set:** The rates that for all clients want to associate with. Choose “Default” or “All” for the 802.11a/b/g/n/ac.



- **Multicast Rate:** The baseline levels that wireless device able to deliver in order to connect to the wireless voice gateway. Lower multicast rates mean weaker, farther signals are allowed to connection. Higher multicast rates mean that only close, strong signals are allowed.
- **NPHY Rate:** Set the Physical Layer rate. The rate always set “Use Legacy Rate”.
- **Rate:** It decides the speed of data transmission. There are several rates provided here for you to choose. Choose any one of it according to your needs by using the drop-down menu.
- **Beacon Interval:** Set the period of beacon transmissions to allow mobile stations to locate and identify a BSS. The measure unit is “time units” (TU) of 1024 microseconds. (Value range: 1~65535)
- **DTIM Interval:** The value you set here is used to inform mobile stations when multicast frames that have been buffered at the Wireless Voice Gateway will be delivered and how often that delivery occurs. (Value range: 1~255)
- **Fragmentation Threshold:** Set the number of the fragmenting frames to make the data to be delivered without errors induced by the interference. Frames longer than the value you set here are fragmented before the initial transmission into fragments no longer than the value of the threshold. (Value range: 256~ 2346)
- **RTS Threshold:** Set the value for sending a request to the destination. All the frames of a length greater than the threshold that you set here will be sent with the four-way frame exchange. And, a length less than or equal to the value that you set will not be proceeded by RTS. (Value range: 0~ 2347)



Bridging

The Bridging page provides a location where settings can be adjusted related to the WDS (**Wireless Distribution System**) feature.

WDS is a system that enables the interconnection of access points wirelessly. It may also be referred to as repeater mode because it appears to bridge and accept wireless clients at the same time (unlike traditional bridging).

The wireless gateway can be placed in a mode that allows the gateway to communicate with other “extender” wireless access points either exclusively or mixed with communications to local PCs. Use this page to designate the Remote Bridges the gateway is allowed to communicate with, and to select the Wireless Bridging mode.

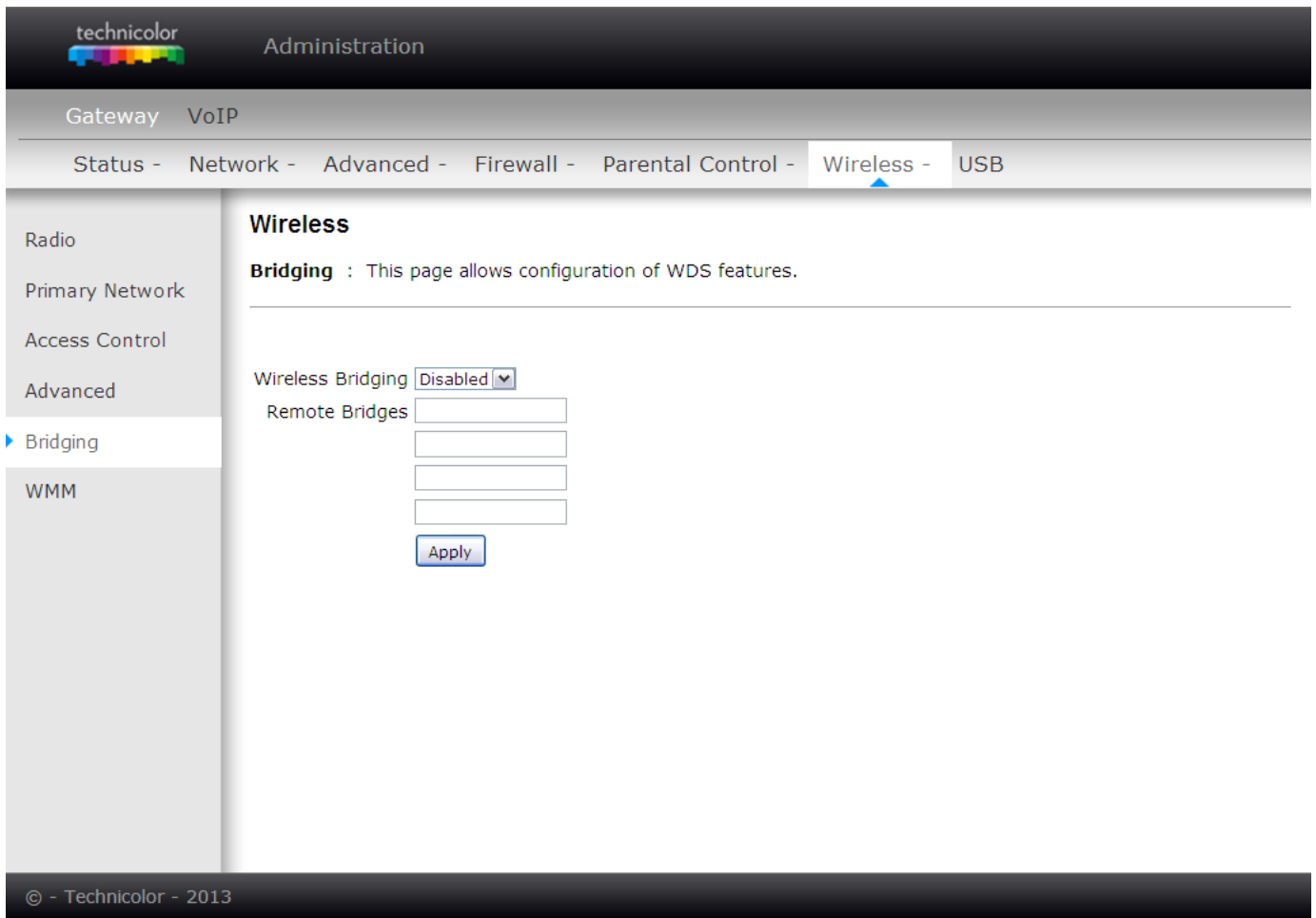

Fig. 2-49 Gateway\Wireless\Bridging

- **Wireless Bridging:** Choose “Disabled” to shutdown this function; select Enabled to turn on the function of WDS.
- **Remote Bridges:** Enter the MAC Addresses of the remote Bridges to relay the signals for each other.
- **Apply:** After proper configuration, click Apply to invoke the settings.



802.11 Wi-Fi Multimedia:

Wi-Fi Multimedia (WMM) is a component of the IEEE 802.11e wireless LAN standard for quality of service (QoS). The QoS assigns priority to the selected network traffic and prevents packet collisions and delays thus improving VoIP calls and watching video over WLANs.

Administration

Gateway VoIP

Status - Network - Advanced - Firewall - Parental Control - **Wireless** - USB

Wireless

802.11 Wi-Fi Multimedia : This page allows configuration of the Wi-Fi Multimedia QoS.

WMM Support No-Acknowledgement Power Save Support

EDCA AP Parameters:	CWmin	CWmax	AIFSN	TXOP(b) Limit (usec)	TXOP(a/g) Limit (usec)	Discard Oldest First
AC_BE	15	63	3	0	0	<input type="button" value="Off"/>
AC_BK	15	1023	7	0	0	<input type="button" value="Off"/>
AC_VI	7	15	1	6016	3008	<input type="button" value="Off"/>
AC_VO	3	7	1	3264	1504	<input type="button" value="Off"/>

EDCA STA Parameters:	CWmin	CWmax	AIFSN	TXOP(b) Limit (usec)	TXOP(a/g) Limit (usec)	Discard Oldest First
AC_BE	15	63	3	0	0	<input type="button" value="Off"/>
AC_BK	15	1023	7	0	0	<input type="button" value="Off"/>
AC_VI	7	15	1	6016	3008	<input type="button" value="Off"/>
AC_VO	3	7	1	3264	1504	<input type="button" value="Off"/>

EDCA STA Parameters:	CWmin	CWmax	AIFSN	TXOP(b) Limit (usec)	TXOP(a/g) Limit (usec)	Discard Oldest First
AC_BE	15	1023	3	0	0	<input type="button" value="Off"/>
AC_BK	15	1023	7	0	0	<input type="button" value="Off"/>
AC_VI	7	15	2	6016	3008	<input type="button" value="Off"/>
AC_VO	3	7	2	3264	1504	<input type="button" value="Off"/>

WMM TXOP Short Retry Parameters:	Short Fallbk limit	Long Retry limit	Long Fallbk limit	Max Rate in 500kbps	
AC_BE	7	3	4	2	0
AC_BK	7	3	4	2	0
AC_VI	7	3	4	2	0
AC_VO	7	3	4	2	0

© - Technicolor - 2013

Fig.2-50 Gateway\Wireless\WMM

- **Enable WMM:** This field allows you to enable WMM to improve multimedia transmission.
- **Enable WMM No-Acknowledgement:** This field allows you to enable WMM No-Acknowledgement.



- **Power Save Support:** This field allows you to enable WMM Power-Save-Support.
- **EDCA AP parameters:** proposal : specifies the transmit parameter for traffic transmitted from the AP to the STA for the 4 Access Categories: Best effort (AC_BE), Background (AC_BK) Video (AC_VI) and voice (AC_VO). Transmit parameters include contention window (CWmin CWmax) , arbitration Inter Frame Spacing Number AIFSN, and Transmit opportunity Limit (TXOP limit) . Admission Control specifies if admission control is enforced for the Access categories. Discard Oldest first specified the discard policy for the queues , On discards the oldest first ; off discards the newest first.
- **EDCA STA parameters:** proposal : specifies the transmit parameter for traffic transmitted from the STA to the AP for the 4 Access Categories :Best effort (AC_BE), Background (AC_BK) Video (AC_VI) and voice AC_VO. Transmit parameters include contention window (CWmin CWmax) , arbitration Inter Frame Spacing Number AIFSN, and Transmit opportunity Limit (TXOP limit) .
- **WMM TXOP parameters:** proposal : specifies the transmit parameter for traffic transmitted from the TXOP to the AP for the 4 Access Categories :Best effort (AC_BE), Background (AC_BK) Video (AC_VI) and voice(AC_VO). Transmit parameters include Short Retry Limit , Short Fallbk Limit , Long Retry Limit , Long Fallbk Limit , and Max Rate in 500kbps.

Gateway – USB Web Page Group

Media Server

This page controls configuration and scanning of the Gateway's media server.

Choose Scan all Files will scan your approved USB devices for sharing files. Scan Files by Type for specific file type or all of types for sharing. Choose file types form **Available File Types** to **Selected File Types**.

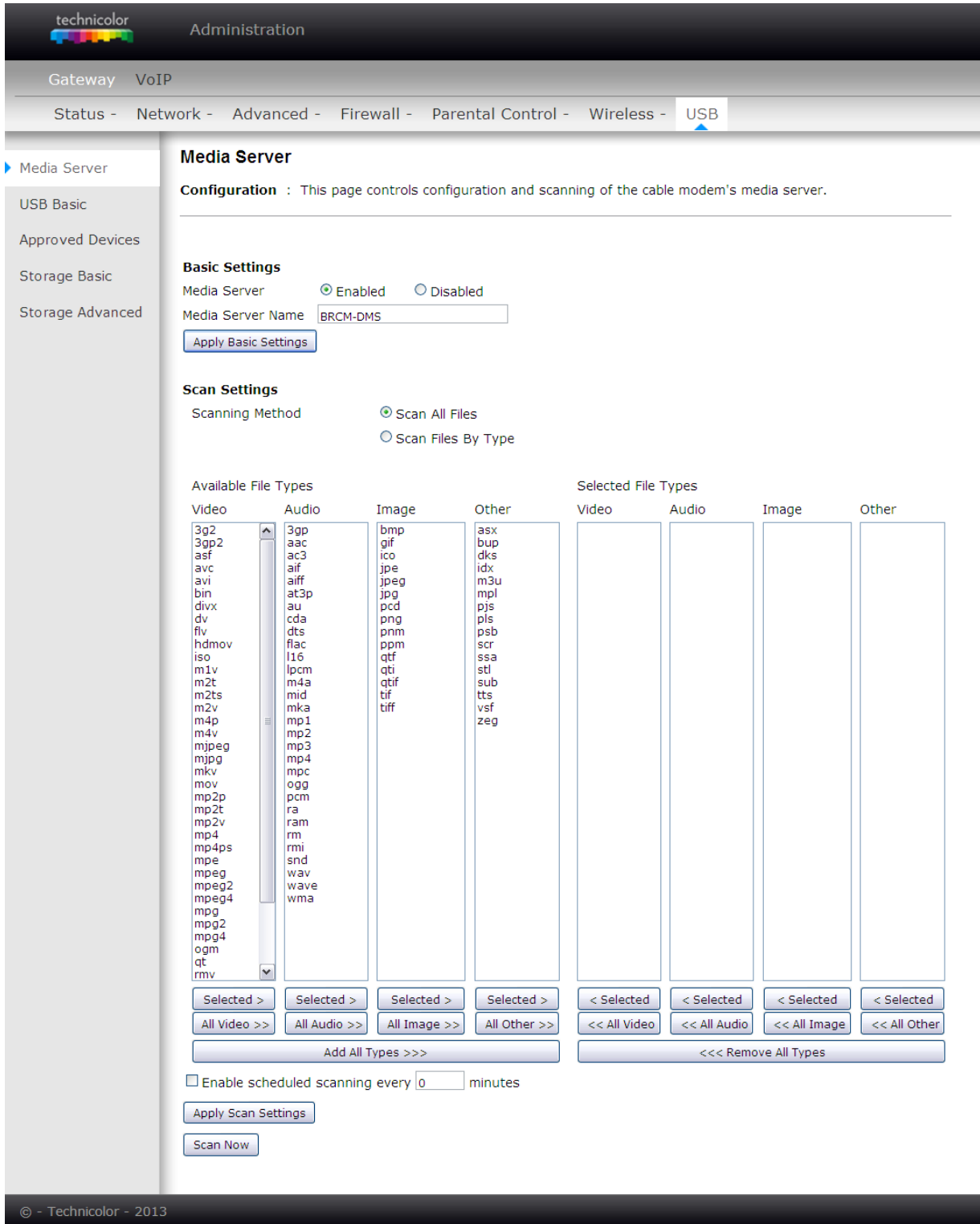

The screenshot shows the Technicolor Gateway Administration interface. The top navigation bar includes 'Gateway' and 'VoIP'. Below it, a menu shows 'Status', 'Network', 'Advanced', 'Firewall', 'Parental Control', 'Wireless', and 'USB' (selected). The left sidebar lists 'Media Server' (selected), 'USB Basic', 'Approved Devices', 'Storage Basic', and 'Storage Advanced'. The main content area is titled 'Media Server' and contains the following configuration options:

- Configuration:** This page controls configuration and scanning of the cable modem's media server.
- Basic Settings:**
 - Media Server: Enabled Disabled
 - Media Server Name:
 - Apply Basic Settings
- Scan Settings:**
 - Scanning Method: Scan All Files Scan Files By Type
- File Type Selection:**

Available File Types				Selected File Types			
Video	Audio	Image	Other	Video	Audio	Image	Other
3g2 3gp2 asf avc avi bin divx dv flv hdmov iso m1v m2t m2ts m2v m4p m4v mjpeg mjpg mkv mov mp2p mp2t mp2v mp4 mp4ps mpe mpeg mpeg2 mpeg4 mpg mpg2 mpg4 ogm qt rmv	3gp aac ac3 aif aiff at3p au cda dts flac l16 lpcm m4a mid mka mp1 mp2 mp3 mp4 mpc ogg pcm ra ram rm rmi snd wav wave wma	bmp gif ico jpe jpeg jpg pcd png pnm ppm qtf qti qtif tif tiff	asx bup dks idx m3u mpl pjs pls psb scr ssa sti sub tts vsf zeg				
<input type="button" value="Selected >"/>	<input type="button" value="Selected >"/>	<input type="button" value="Selected >"/>	<input type="button" value="Selected >"/>	<input type="button" value=" < Selected"/>	<input type="button" value=" < Selected"/>	<input type="button" value=" < Selected"/>	<input type="button" value=" < Selected"/>
<input type="button" value="All Video >>"/>	<input type="button" value="All Audio >>"/>	<input type="button" value="All Image >>"/>	<input type="button" value="All Other >>"/>	<input type="button" value=" << All Video"/>	<input type="button" value=" << All Audio"/>	<input type="button" value=" << All Image"/>	<input type="button" value=" << All Other"/>
<input type="button" value="Add All Types >>>"/>				<input type="button" value=" <<< Remove All Types"/>			
- Enable scheduled scanning every minutes
- Apply Scan Settings
- Scan Now

Fig.2-51 Gateway/USB/Media Server



USB Basic settings

This page allows basic control of the USB devices shared over the network.

Enable USB Devices connected to the USB port: This field controls which USB device (Key or Hard Disk) can be connected to the Gateway. "All" will authorize all USB devices. "Approved" will authorize devices that have been previously approved on this gateway. "None" will block any USB Device on the Gateway. To approve devices (PC), click on the button "Approved Devices"

Enable USB Devices to be Shared Storage: Yes or No to decide if you share or not the content of the USB device. Click on "Storage Configuration" button to access the web pages to configure the Storage Device.

Enable the Media Server (DLNA): Yes or No to activate or the not the DLNA Server (DLNA: Digital Living Network Alliance). To configure the DLNA server, click on the button "Media Server Configuration".

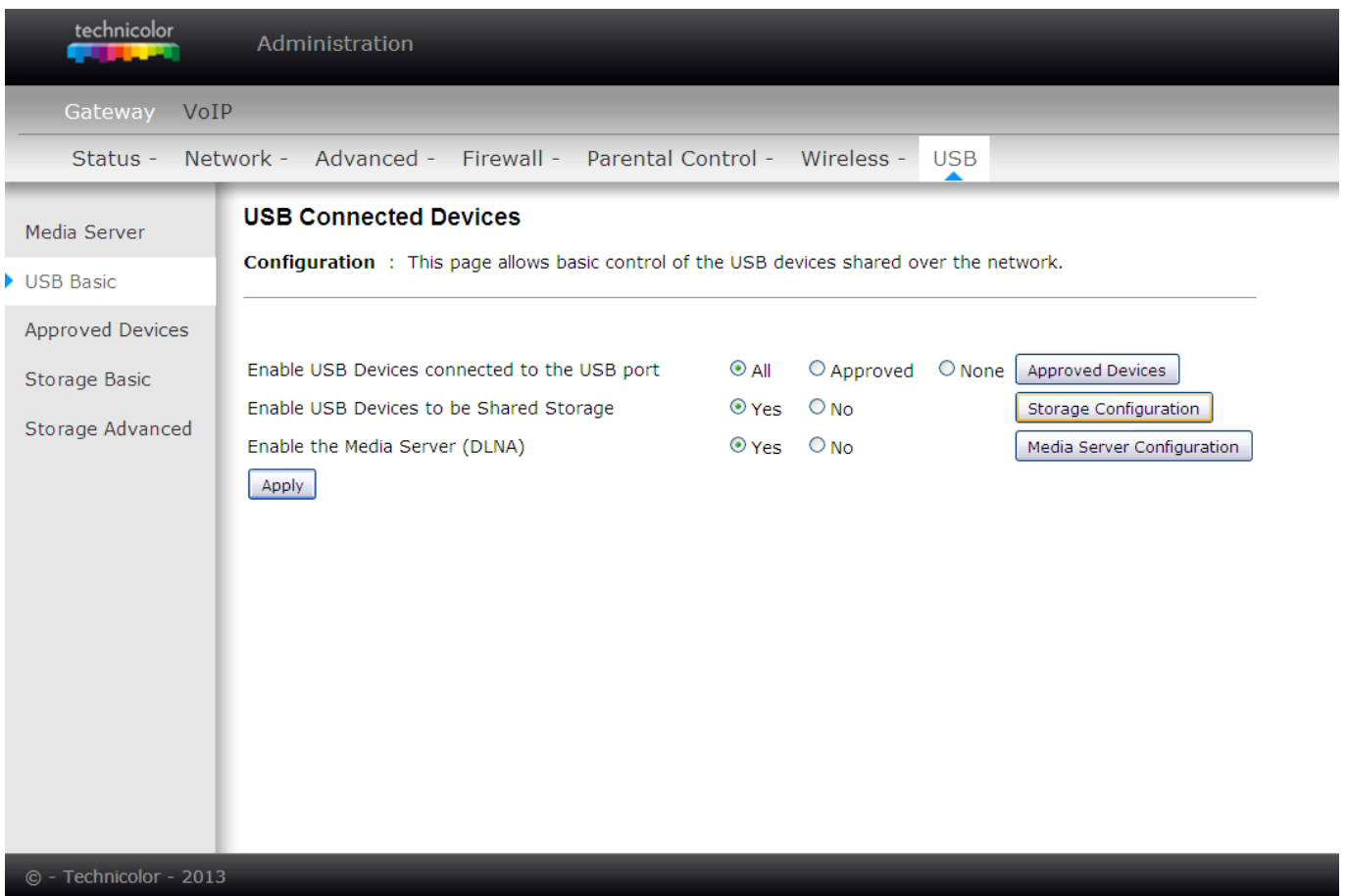

Fig.2-52 Gateway/USB/USB Basic



Approved Devices settings

This page allows the configuration of the USB storage device(s) shared over the network.

Add Available USB Devices as Approved USB Devices then apply changes. If you want to remove USB devices, propose you press “Safely Remove Device” button first.

The screenshot shows the 'Administration' page for a Technicolor Gateway, specifically the 'USB' settings under 'Network Attached Storage'. The left sidebar contains navigation options: Media Server, USB Basic, Approved Devices (selected), Storage Basic, and Storage Advanced. The main content area is titled 'Network Attached Storage' and includes a description of the 'Approved Device Settings' page. Below the description, there are radio buttons to 'Enable USB Devices connected to the USB port' with options 'All' (selected), 'Approved', and 'None'. There are two tables: 'Approved USB Devices' and 'Available USB Devices'. Both tables have columns for 'Select', 'Volume Name', 'Manufacturer', 'Product', 'Free Space', 'Used Space', and 'Total Space'. The 'Approved' table has a 'Remove' button, and the 'Available' table has an 'Add' button. At the bottom of the main area are 'Apply Changes' and 'Refresh List' buttons, and a 'Safely Remove Device' button at the very bottom.

technicolor Administration

Gateway VoIP

Status - Network - Advanced - Firewall - Parental Control - Wireless - USB

Media Server

USB Basic

Approved Devices

Storage Basic

Storage Advanced

Network Attached Storage

Approved Device Settings : This page allows the configuration of the USB storage devices shared over the network.

Enable USB Devices connected to the USB port: All Approved None

Approved USB Devices						
Select	Volume Name	Manufacturer	Product	Free Space	Used Space	Total Space
Remove						

Available USB Devices						
Select	Volume Name	Manufacturer	Product	Free Space	Used Space	Total Space
Add						

Apply Changes Refresh List

Safely Remove Device

© - Technicolor - 2013

Fig.2-53 Gateway/USB/Approved Devices



Storage Basic

This page shows the status of the USB folders shared over the network.

Basic option defines shared files in all approved devices and specified folders or only specified folders. You can edit Shared Network Folders and observe the detail of folders.

The screenshot shows the Technicolor Administration web interface. At the top, there is a navigation bar with the Technicolor logo and the word 'Administration'. Below this is a secondary navigation bar with 'Gateway' and 'VoIP'. A main navigation menu includes 'Status -', 'Network -', 'Advanced -', 'Firewall -', 'Parental Control -', 'Wireless -', and 'USB'. The 'USB' menu item is selected and highlighted with a blue arrow. On the left side, there is a sidebar menu with options: 'Media Server', 'USB Basic', 'Approved Devices', 'Storage Basic' (which is selected with a blue arrow), and 'Storage Advanced'. The main content area is titled 'Network Attached Storage' and contains the following elements:

- Basic Settings**: A text description stating 'This page shows the status of the USB folders shared over the network.'
- Network/Device Name**: A text input field containing the value 'TC7200-DMS'.
- Default Sharing**: Two radio button options:
 - Share specified folders and all approved devices
 - Only share specified folders
- An 'Apply' button.
- Shared Network Folders**: A table with the following columns: Share Name, Device, Folder, Read Access, Write Access, Free Space, Used Space, and Total Space. The table is currently empty.
- 'Edit' and 'Refresh' buttons located below the table.

At the bottom left of the interface, there is a copyright notice: '© - Technicolor - 2013'.

Fig.2-54 Gateway/USB/Storage Basic



Storage Advanced

This page shows the status of the folders shared over the network.

Advanced option provides FTP option to share files as a FTP server.

technicolor Administration

Gateway VoIP

Status - Network - Advanced - Firewall - Parental Control - Wireless - USB

Media Server

USB Basic

Approved Devices

Storage Basic

Storage Advanced

Network Attached Storage

Advanced Settings : This page shows the status of the folders shared over the network.

Network/Device Name:

Workgroup Name:

Protocols			
Enable	Access Method	Link	Port
<input checked="" type="checkbox"/>	Windows Network Connection	\\TC7200-DMS	
<input type="checkbox"/>	FTP (via internet)	ftp://192.168.0.10/	Port 21

Available Network Folders								
Actions	Share Name	Device	Folder	Read Access	Write Access	Free Space	Used Space	Total Space
<input type="button" value="Create Network Folder"/>								

© - Technicolor - 2013

Fig.2-55 Gateway/USB/Storage Advanced

VoIP – Basic Web Page Group

Basic LAN

This page displays the basic LAN status of this device, including the downstream and upstream status, device information, and interface parameters. You can select specific interface from the Interface Name drop-down menu...

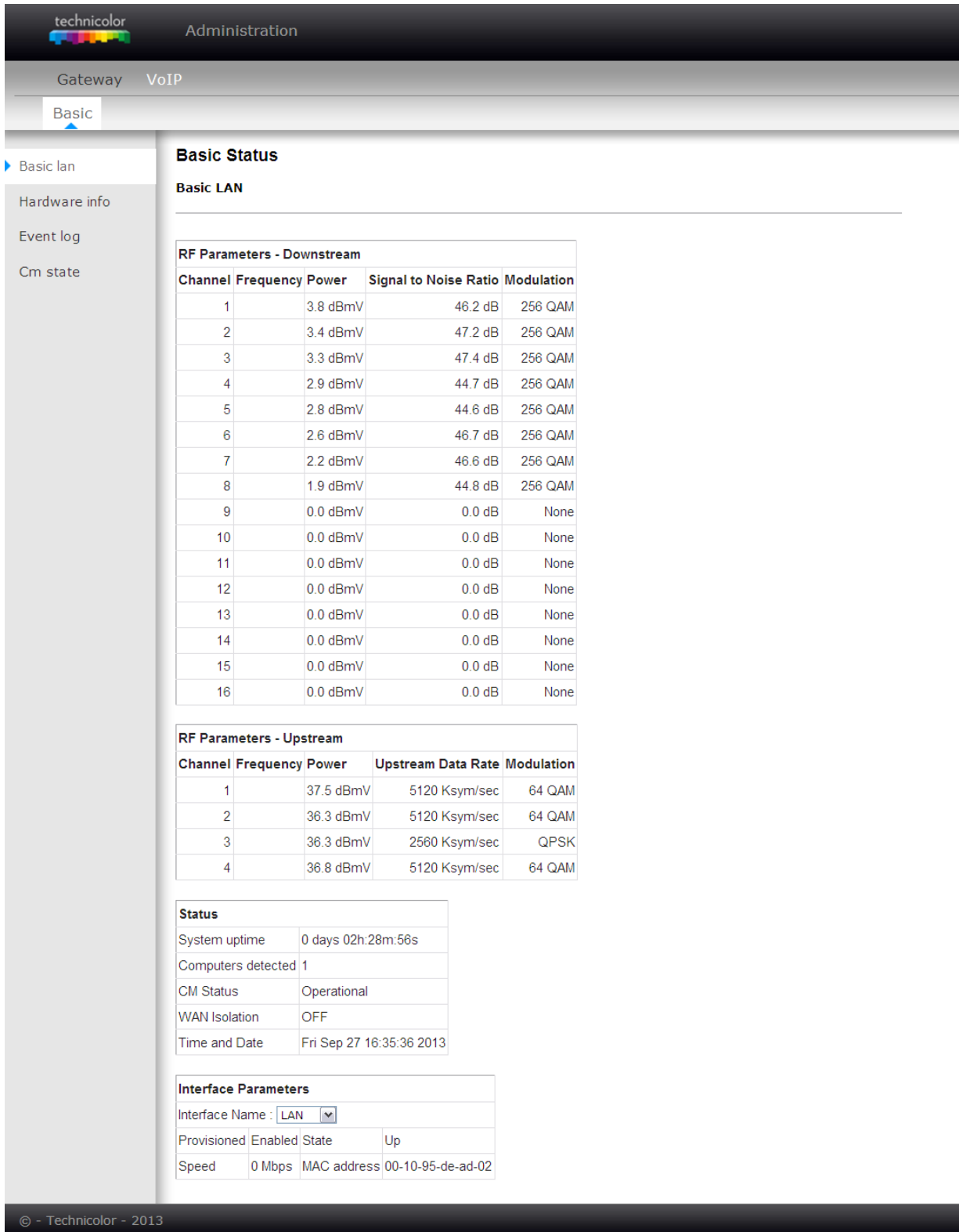

The screenshot shows the 'Basic LAN' status page in the Technicolor Administration interface. The page is titled 'Basic Status' and 'Basic LAN'. It contains three main sections: 'RF Parameters - Downstream', 'RF Parameters - Upstream', and 'Status'. The 'RF Parameters - Downstream' table lists 16 channels with their respective power, signal-to-noise ratio, and modulation. The 'RF Parameters - Upstream' table lists 4 channels with their respective power, upstream data rate, and modulation. The 'Status' section provides system uptime, number of computers detected, CM status, WAN isolation, and time and date. The 'Interface Parameters' section shows the selected interface name (LAN), its provisioned state (Enabled), and its speed (0 Mbps).

RF Parameters - Downstream				
Channel	Frequency	Power	Signal to Noise Ratio	Modulation
1		3.8 dBmV	46.2 dB	256 QAM
2		3.4 dBmV	47.2 dB	256 QAM
3		3.3 dBmV	47.4 dB	256 QAM
4		2.9 dBmV	44.7 dB	256 QAM
5		2.8 dBmV	44.6 dB	256 QAM
6		2.6 dBmV	46.7 dB	256 QAM
7		2.2 dBmV	46.6 dB	256 QAM
8		1.9 dBmV	44.8 dB	256 QAM
9		0.0 dBmV	0.0 dB	None
10		0.0 dBmV	0.0 dB	None
11		0.0 dBmV	0.0 dB	None
12		0.0 dBmV	0.0 dB	None
13		0.0 dBmV	0.0 dB	None
14		0.0 dBmV	0.0 dB	None
15		0.0 dBmV	0.0 dB	None
16		0.0 dBmV	0.0 dB	None

RF Parameters - Upstream				
Channel	Frequency	Power	Upstream Data Rate	Modulation
1		37.5 dBmV	5120 Ksym/sec	64 QAM
2		36.3 dBmV	5120 Ksym/sec	64 QAM
3		36.3 dBmV	2560 Ksym/sec	QPSK
4		36.8 dBmV	5120 Ksym/sec	64 QAM

Status	
System uptime	0 days 02h:28m:56s
Computers detected	1
CM Status	Operational
WAN Isolation	OFF
Time and Date	Fri Sep 27 16:35:36 2013

Interface Parameters			
Interface Name :	LAN		
Provisioned	Enabled	State	Up
Speed	0 Mbps	MAC address	00-10-95-de-ad-02

Fig. 2-56 VoIP\Basic\Basic LAN



Hardware Info

The hardware Info is displayed on this page.

The screenshot shows the Technicolor Administration web interface. At the top, there is a navigation bar with the Technicolor logo and the word 'Administration'. Below this, there are tabs for 'Gateway' and 'VoIP'. Under the 'VoIP' tab, there is a sub-tab for 'Basic'. On the left side, there is a vertical menu with options: 'Basic lan', 'Hardware info' (which is selected and highlighted with a blue arrow), 'Event log', and 'Cm state'. The main content area is titled 'Basic Status' and contains a section for 'Hardware Info'. This section displays three tables of system information.

System			
HW Revision	1.0	VENDOR	Technicolor
BOOT Revision	2.5.0	SW Revision	STEF.01.01.T1
MODEL	TC7210	Software Version	STEF.01.01.T1
Serial Number	00997348500003		

MTA Hardware Information	
Mta Serial Number	00997348500003

Software Build and Revision	
Firmware Name	TC7210-EF.01.01.T1-130813-F-1C1.bin
Firmware Build Time	10:30:17 Tue Aug 13 2013

© - Technicolor - 2013

Fig. 2-57 VoIP\Basic\Hardware Info

Event Log

The Docsis and PacketCable event logs are displayed on this web page.

© - Technicolor - 2013

Fig. 2-58 VoIP\Basic\Event log\DOCSIS

© - Technicolor - 2013

Fig. 2-59 VoIP\Basic\Event log\PacketCable



CM State

This page shows the current state of the cable modem.

The screenshot shows the Technicolor Administration interface. At the top, there is a navigation bar with the Technicolor logo and the word 'Administration'. Below this, there are tabs for 'Gateway' and 'VoIP'. Under the 'VoIP' tab, there is a sub-tab for 'Basic'. On the left side, there is a sidebar menu with options: 'Basic lan', 'Hardware info', 'Event log', and 'Cm state' (which is selected). The main content area is titled 'Basic Status' and contains a section for 'CM State'. Below this section is a table with the following data:

Line	Status
Line 1 State	On-Hook
Line 2 State	On-Hook
Line 1 Phone Number	1001
Line 2 Phone Number	1002

At the bottom of the interface, there is a footer that reads '© - Technicolor - 2013'.

Fig. 2-60 VoIP\Basic\Cm state

CHAPTER 3: NETWORKING

Communications

Data communication involves the flow of packets of data from one device to another. These devices include personal computers, Ethernet, cable modems, digital routers and switches, and highly integrated devices that combine functions, like the Wireless Cable Gateway.

The gateway integrates the functionality often found in two separate devices into one. It's both a cable modem and an intelligent wireless voice gateway networking device that can provide a host of networking features, such as NAT and firewall. Fig.3-1 illustrates this concept, with the cable modem (CM) functionality on the left, and networking functionality on the right. In this figure, the numbered arrows represent communication based on source and destination, as follows:

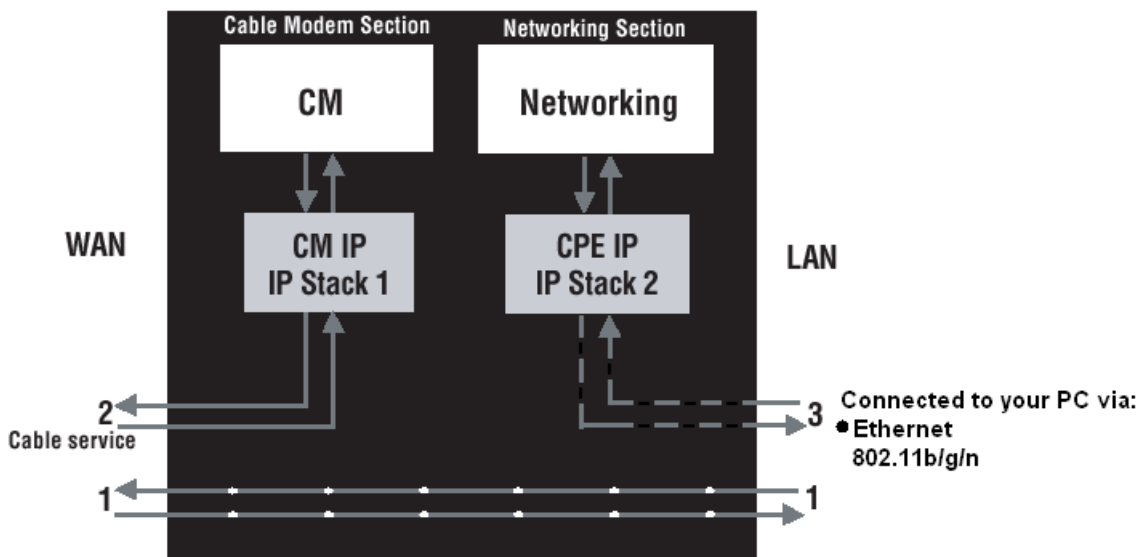

Fig.3-1 Communication between your PCs and the network side

Type of Communication

1. Communication between the Internet and your PCs
Example: The packets created by your request for a page stored at a web site, and the contents of that page sent to your PC.
2. Communication between your cable company and the cable modem side
Example: When your cable modem starts up, it must initialize with the cable company, which requires the cable company to communicate directly with the cable modem itself.
3. Communication between your PCs and the networking side

Example: The Wireless Cable Gateway offers a number of built-in web pages which you can use to configure its networking side; when you communicate with the networking side, your communication is following this path. Each packet on the Internet addressed to a PC in your home travels from the Internet down-stream on the cable company's system to the WAN side of your Wireless Cable Gateway. There it enters the Cable Modem section, which inspects the packet, and based on the results, proceeds to either forward or block the packet from proceeding on to the Networking section. Similarly, the Networking section then decides whether to forward or block the packet from proceeding on to your PC.

Communication from your home device to an Internet device works similarly, but in reverse, with the packet traveling upstream on the cable system.



Cable Modem (CM) Section

The cable modem (or CM) section of your gateway uses DOCSIS or EURO-DOCSIS Standard cable modem technology. DOCSIS or EURO-DOCSIS specifies that TCP/IP over Ethernet style data communication be used between the WAN interface of your cable modem and your cable company.

A DOCSIS or EURO-DOCSIS modem, when connected to a Cable System equipped to support such modems, performs a fully automated initialization process that requires no user intervention. Part of this initialization configures the cable modem with a CM IP (Cable Modem Internet Protocol) address, as shown in Figure 3-2, so the cable company can communicate directly with the CM itself.

Networking Section

The Networking section of your gateway also uses TCP/IP (Transmission Control Protocol/ Internet Protocol) for the PCs you connected on the LAN side. TCP/IP is a networking protocol that provides communication across interconnected networks, between computers with diverse hardware architectures and various operating systems.

TCP/IP requires that each communicating device be configured with one or more TCP/IP stacks, as illustrated by Fig.3-2. On a PC, you often use software that came with the PC or its network interface (if you purchased a network interface card separately) to perform this configuration. To communicate with the Internet, the stack must also be assigned an IP (Internet Protocol) address. 192.168.100.1 is an example of an IP address. A TCP/IP stack can be configured to get this IP address by various means, including a DHCP server, by you directly entering it, or sometimes by a PC generating one of its own.

Ethernet requires that each TCP/IP stack on the Wireless Cable Gateway also have associated with it an Ethernet MAC (Media Access Control) address. MAC addresses are permanently fixed into network devices at the time of their manufacture. 00:90:64:12:B1:91 is an example of a MAC address.

Data packets enter and exit a device through one of its network interfaces. The gateway offers Ethernet and 802.11b/g/n wireless network interfaces on the LAN side and the DOCSIS network interface on the WAN side.

When a packet enters a network interface, it is offered to all the TCP/IP stacks associated with the device side from which it entered. But only one stack can accept it — a stack whose configured Ethernet address matches the Ethernet destination address inside the packet. Furthermore, at a packet's final destination, its destination IP address must also match the IP address of the stack.

Each packet that enters a device contains source MAC and IP addresses telling where it came from, and destination MAC and IP addresses telling where it is going to. In addition, the packet contains all or part of a message destined for some application that is running on the destination device. IRC used in an Internet instant messaging program, HTTP used by a web browser, and FTP used by a file transfer program are all examples of applications. Inside the packet, these applications are designated by their port number. Port 80, the standard HTTP port, is an example of a port number.

The Networking section of the router performs many elegant functions by recognizing different packet types based upon their contents, such as source and destination MAC address, IP address, and ports.

Three Networking Modes

Your gateway can be configured to provide connectivity between your cable company and your home LAN in any one of three Networking Modes: CM, RG, and CH. This mode setting is under the control of your cable company, who can select the mode to match the level of home networking support for which you have subscribed. All units ship from the factory set for the RG mode, but a configuration file which the cable company sends the cable modem section during its initialization can change it.

Cable Modem (CM) Mode

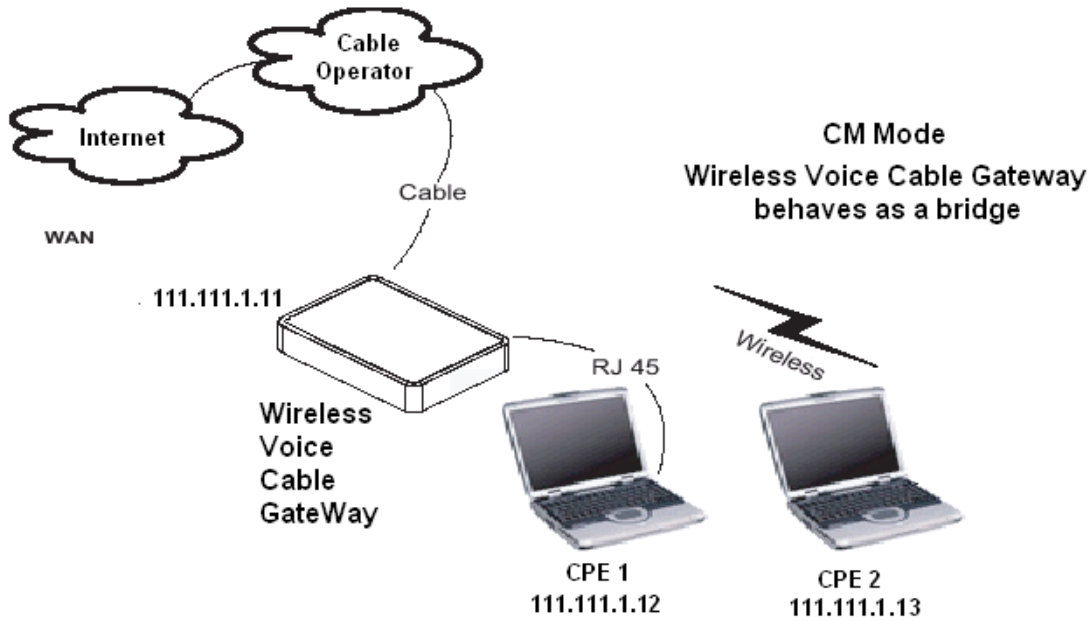

Fig. 3-2 Cable Modem Mode

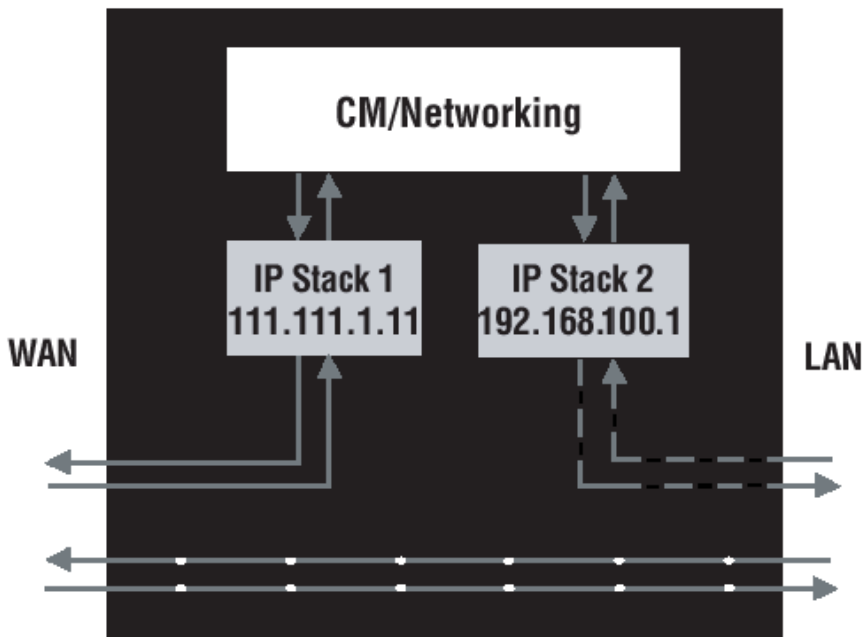

Fig. 3-3 Two IP stacks are activated in cable modem mode

CM (Cable Modem) Mode provides basic home networking. In this mode, two IP stacks are active:

- IP Stack 1 - for use by the cable company to communicate with the cable modem section only. This stack receives its IP address from the cable company during CM initialization. It uses the MAC address printed on the label attached to the Wireless Cable gateway.
- IP Stack 2 - for use by you, the end user, to communicate with the cable modem and Networking sections, to access the internal web page diagnostics and configuration. This stack uses a fixed IP address: 192.168.100.1. It uses a MAC address 00:10:95:FF:FF:FE.

With CM Mode, your cable company must provide one IP address for the CM section, plus one for each PC you connect from their pool of available addresses. Your cable company may have you or your

installer manually enter these assigned addresses into your PC, or use a DHCP Server to communicate them to your PCs, or use a method that involves you entering host names into your PCs.

Note that in CM Mode, packets passing to the Internet to/from your PCs do not travel through any of the IP stacks; instead they are directly bridged between the WAN and LAN sides.

Residential Gateway (RG) Mode

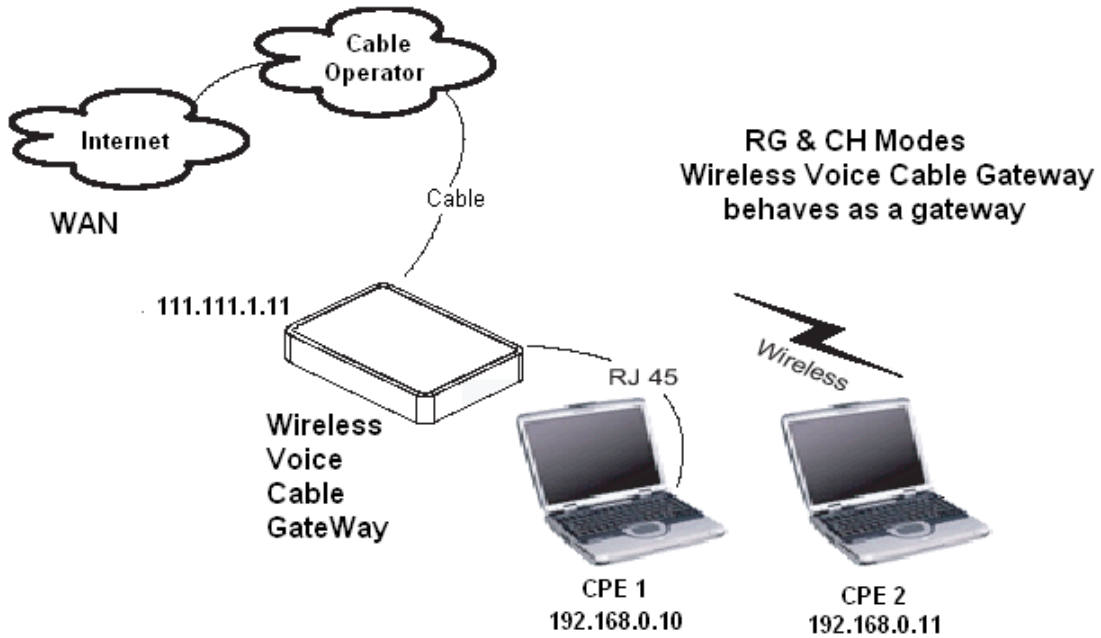

Fig. 3-4 Residential Gateway Mode

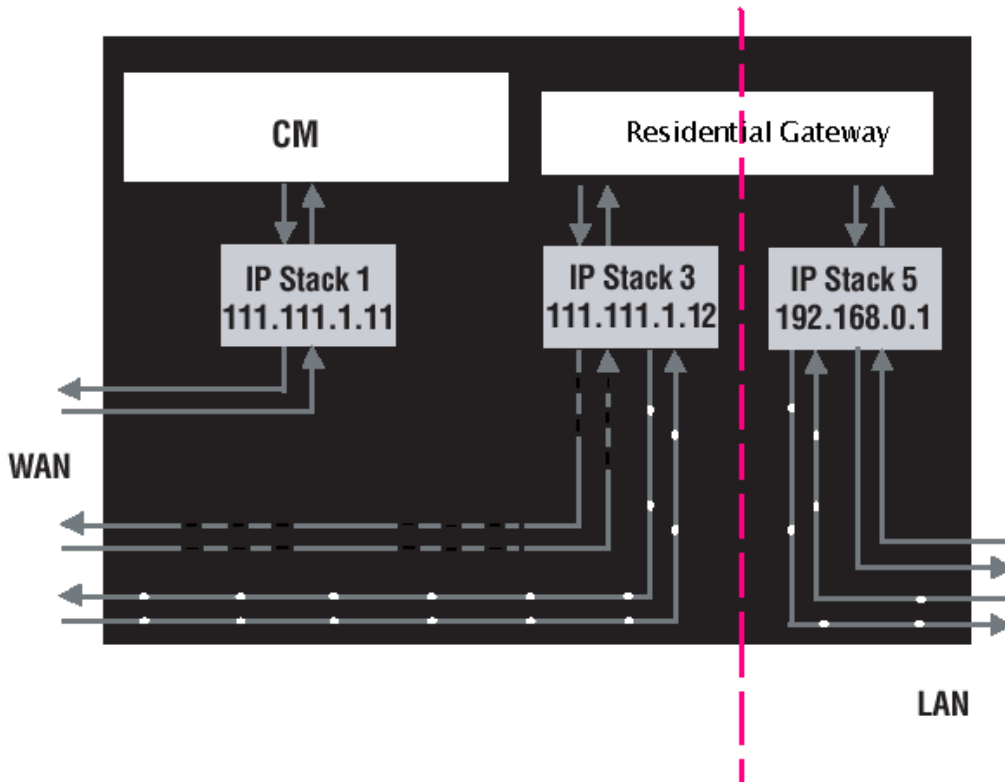

Fig. 3-5 Three IP stacks are activated in cable modem mode

RG (Residential Gateway) Mode provides basic home networking plus NAT (Network Address Translation). In this mode, three IP stacks are active:

- IP Stack 1 - for use by the cable company to communicate with the Cable Modem section only. This stack receives its IP address from the cable company during CM initialization. It uses the MAC



address printed on the label attached to the Wireless Cable Gateway.

- IP Stack 3 - for use by you to remotely (i.e. from somewhere on the WAN side, such as at your remote workplace) communicate with the Cable Modem and Networking sections, to remotely access the internal web page diagnostics and configuration. This stack is also used by your cable company to deliver packets between the Internet and the gateway's networking section so they can be routed to/from your PCs. This stack requires an IP address assigned by the cable company from their pool of available addresses. Your cable company may have you or your installer manually enter assigned addresses into your gateway, or use a DHCP Server to communicate them, or use a method that involves you entering host names. This stack uses a MAC address of MAC label + 2 (the MAC label is found on the bottom of the unit). E.g., if the MAC address is 00:90:64:12:B1:91, this MAC address would be 00:90:64:12:B1:93.
- IP Stack 5 - for use by you to locally (i.e. from somewhere on the LAN side in your home) communicate with the Cable Modem and Networking sections, to access the internal web page diagnostics and configuration. This stack is also used by the gateway's networking section to route packets between the gateway's Networking section and your PCs. This stack uses a fixed IP address: 192.168.0.1. It uses a MAC address of MAC label + 4 (the MAC label is found on the bottom of the unit). E.g., if the MAC address is 00:90:64:12:B1:91, this MAC address would be 00:90:64:12:B1:95.

With RG Mode, your cable company must provide one IP address for the CM section, plus one for the Networking section, from their pool of available addresses. With RG Mode, each PC you connect gets an IP address from a DHCP Server that is part of the Networking section of the gateway.



CHAPTER 4: ADDITIONAL INFORMATION

Frequently Asked Questions

Q. What if I don't subscribe to cable TV?

A. If cable TV is available in your area, data and voice service may be made available with or without cable TV service. Contact your local cable company for complete information on cable services, including high-speed internet access.

Q. How do I get the system installed?

A. Professional installation from your cable provider is strongly recommended. They will ensure proper cable connection to the modem and your computer. However, your retailer may have offered a self installation kit, including the necessary software to communicate with your cable ISP.

Q. Once my Wireless Voice Gateway is connected, how do I get access to the Internet?

A. Your local cable company provides your internet service*, offering a wide range of services including email, chat, and news and information services, and a connection to the World Wide Web.

Q. It seems that the wireless network is not working

A. Check the Wireless LED on the front panel. If it is no lighted, press on the WPS button shortly, less than 1 second, on the side of the modem, and then check again the Wireless LED. If it is lighted, then the Wireless transmission is enabled.

Q. Can I watch TV, surf the Internet, and talk to my friends through the Wireless Voice Gateway at the same time?

A. Absolutely!

Q. What do you mean by "Broadband?"

A. Simply put, it means you'll be getting information through a "bigger pipe," with more bandwidth, than a standard phone line can offer. A wider, "broader" band means more information, more quickly.

Q. What is Euro-DOCSIS and what does it mean?

A. "Data over Cable Service Interface Specifications" is the industry standard that most cable companies are adopting as they upgrade their systems. Should you ever decide to move, the Wireless Voice Gateway will work with all upgraded cable systems that are Euro-DOCSIS-compliant.

Q. What is Euro-PacketCable and what does it mean?

A. Euro-PacketCable is the industry standard for telephony services that most cable companies are adopting as they upgrade their systems. Should you ever decide to move, the Wireless Voice Gateway will work with all upgraded cable systems that are Euro-PacketCable compliant.

Q. What is Xpress Technology and what does it mean?

A. It is one of the popular performance-enhancing Wi-Fi technologies, designed to improve wireless network efficiency and boost throughput. It is more efficient in mixed environments, and it can work with 802.11a/b/g networks. When Xpress is turned on, aggregate throughput (the sum of the individual throughput speeds of each client on the network) can improve by **up to 27%** in 802.11g-only networks, and **up to 75%** in mixed networks comprised of 802.11g and 802.11b standard equipment. The



technology achieves higher throughput by re-packaging data, reducing the number of overhead control packets, so that more useful data can be sent during a given amount of time.

* Monthly subscription fee applies.

** Additional equipment required. Contact your Cable Company and ISP for any restrictions or additional fees.



General Troubleshooting

You can correct most problems you have with your product by consulting the troubleshooting list that follows.

I can't access the internet.

- Check all of the connections to your Wireless Voice Gateway.
- Your Ethernet card may not be working. Check each product's documentation for more information.
- The Network Properties of your operating system may not be installed correctly or the settings may be incorrect. Check with your ISP or cable company.

I can't get the modem to establish an Ethernet connection.

- Even new computers don't always have Ethernet capabilities – be sure to verify that your computer has a properly installed Ethernet card and the driver software to support it.
- Check to see that you are using the right type of Ethernet cable.

The modem won't register a cable connection.

- If the modem is in Initialization Mode, the INTERNET light will be flashing. Call your Cable Company if it has not completed this 5-step process within 30 minutes, and note which step it is getting stuck on.
- The modem should work with a standard RG-6 coaxial cable, but if you're using a cable other than the one your Cable Company recommends, or if the terminal connections are loose, it may not work. Check with your Cable Company to determine whether you're using the correct cable.
- If you subscribe to video service over cable, the cable signal may not be reaching the modem. Confirm that good quality cable television pictures are available to the coaxial connector you are using by connecting a television to it. If your cable outlet is "dead", call your Cable Company.
- Verify that the Cable Modem service is Euro-DOCSIS compliant and PacketCable compliant by calling your cable provider.

I don't hear a dial tone when I use a telephone.

- Telephone service is not activated. If the rightmost light on the Wireless Voice Gateway stays on while others flash, check with your TSP or cable company. If the Wireless Voice Gateway is connected to existing house telephone wiring, make sure that another telephone service is not connected. The other service can normally be disconnected at the Network Interface Device located on the outside of the house.
- If using the second line on a two-line telephone, use a 2-line to 1-line adapter cable.

For more Usage and Troubleshooting Tips use the web site links provided on the CD-ROM:

www.technicolor.com



Service Information

If you purchased or leased your Wireless Voice Gateway directly from your cable company, then warranty service for the Digital Cable Modem may be provided through your cable provider or its authorized representative. For information on 1) Ordering Service, 2) Obtaining Customer Support, or 3) Additional Service Information, please contact your cable company. If you purchased your Wireless Voice Gateway from a retailer, see the enclosed warranty card.



Glossary

10/100/1000 BaseT – Unshielded, twisted pair cable with an RJ-45 connector, used with Ethernet LAN (Local Area Network). “10/100/1000” indicates speed (10/100/1000 BaseT), “Base” refers to baseband technology, and “T” means twisted pair cable.

Authentication - The process of verifying the identity of an entity on a network.

DHCP (Dynamic Host Control Protocol) – A protocol which allows a server to dynamically assign IP addresses to workstations on the fly.

Ethernet adapters – A plug-in circuit board installed in an expansion slot of a personal computer. The Ethernet card (sometimes called a Network Interface Card , network adapter or NIC) takes parallel data from the computer, converts it to serial data, puts it into a packet format, and sends it over the 10/100/1000 BaseT LAN cable.

DOCSIS (Data Over Cable Service Interface Specifications) – A project with the objective of developing a set of necessary specifications and operations support interface specifications for Cable Modems and associated equipment.

F Connector – A type of coaxial connector, labeled CABLE IN on the rear of the Wireless Voice Gateway that connects the modem to the cable system.

HTTP (HyperText Transfer Protocol) – Invisible to the user, HTTP is used by servers and clients to communicate and display information on a client browser.

Hub – A device used to connect multiple computers to the Wireless Voice Gateway.

IP Address – A unique, 32-bit address assigned to every device in a network. An IP (Internet Protocol) address has two parts: a network address and a host address. This modem receives a new IP address from your cable operator via DHCP each time it goes through Initialization Mode.

Key exchange - The swapping of mathematical values between entities on a network in order to allow encrypted communication between them.

MAC Address – The permanent “identity” for a device programmed into the Media Access Control layer in the network architecture during the modem’s manufacture.

NID - Network Interface Device, the interconnection between the internal house telephone wiring and a conventional telephone service provider’s equipment. These wiring connections are normally housed in a small plastic box located on an outer wall of the house. It is the legal demarcation between the subscriber’s property and the service provider’s property.

PacketCable – A project with the objective of developing a set of necessary telephony specifications and operations support interface specifications for Wireless Voice Gateways and associated equipment used over the DOCSIS based cable network.

PSTN (Public Switched Telephone Network) – The worldwide voice telephone network which provides dial tone, ringing, full-duplex voice band audio and optional services using standard telephones.

Provisioning - The process of enabling the Media Terminal Adapter (MTA) to register and provide services over the network.



TCP/IP (Transmission Control Protocol/Internet Protocol) – A networking protocol that provides communication across interconnected networks, between computers with diverse hardware architectures and various operating systems.

TFTP - Trivial File Transfer Protocol, the system by which the Media Terminal Adapter's configuration data file is downloaded.

TSP - Telephony Service Provider, an organization that provides telephone services such as dial tone, local service, long distance, billing and records, and maintenance.

Universal Serial Bus (USB) – USB is a “plug-and-play” interface between a computer and add-on devices, such as a Wireless Voice Gateway.

Xpress Technology - One of the popular performance-enhancing WiFi technologies, designed to improve wireless network efficiency and boost throughput. It is more efficient in mixed environments, and it can work with 802.11a/b/g networks.